



Stocking Warehouse and Factory Representatives For:



cendrex

Texas Warehouse Pricing

Pricing Effective November 1 2023 • Pricing Subject To Change Without Prior Notice

DFW Warehouse
2020 Exchange Drive
Arlington, TX 76011

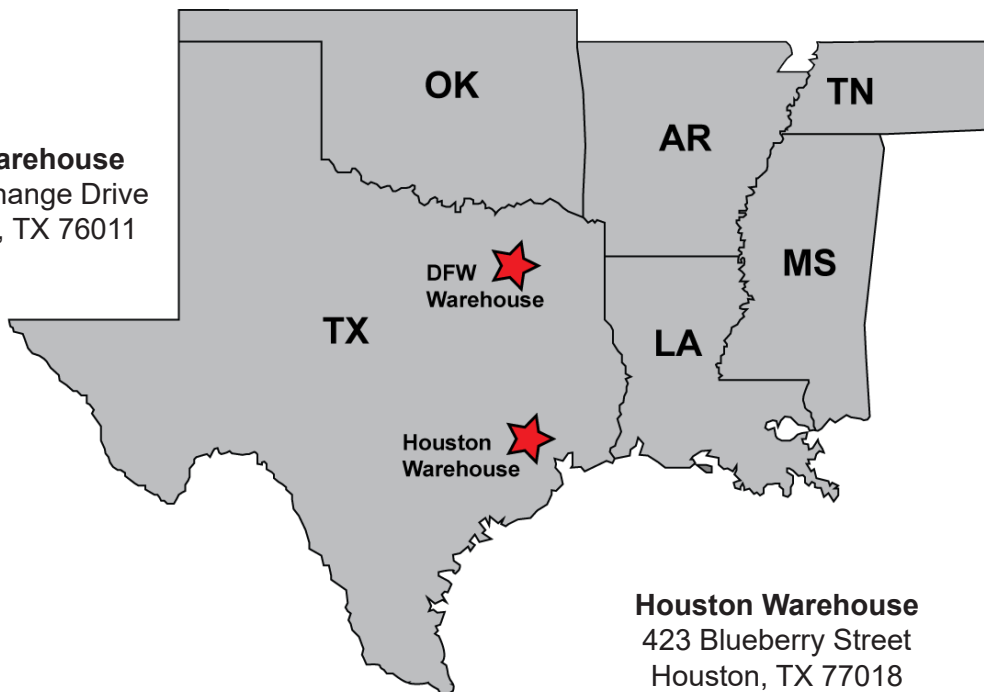

Houston Warehouse
423 Blueberry Street
Houston, TX 77018

855-738-3835 Toll Free • Phone 817-275-3070 • Website: www.ssg-texas.com



Greg Shuck - President
gregshuck@ssg-texas.com
Office Phone: (817) 275-3070 x 221
Cell Phone: (972) 880-1677

Amy Shuck - Office Manager
amyshuck@ssg-texas.com
Office Phone: (817) 275-3070 x 222
Fax: (972) 602-3068

Darrell Hicks, AHC - Outside Sales
(Louisiana, Mississippi,
Arkansas, West Tennessee)
darrellhicks@ssg-texas.com
Cell Phone: (972) 207-6366

Brett Banta - Outside Sales
(South Texas)
brettbanta@ssg-texas.com
Cell Phone: (504) 473-2243

Brad Shuck - Outside Sales
(West Texas / Oklahoma)
bradshuck@ssg-texas.com
Cell Phone (817) 269-5523

CUSTOMER SERVICE

Toll Free: 855-738-3835 • Office Phone: (817) 275-3070 • Fax: (817) 275-3068
Email orders to: orders@ssg-texas.com

**Brad Shuck - Inside Sales/
Customer Service**
orders@ssg-texas.com
Office Phone: (817) 275-3070 x 223

**SSG Texas is proud to represent these
fine manufacturers of Division 8 & 10 products**



cendrex

**SSG Texas now stocking
Cendrex access doors!**



**Contact your local SSG Texas sales
representative for more information,
pricing, and stock availability.**





We are your source for custom Quick Ship stainless steel and galvanized hollow metal doors and frames

But.....did you know that we are also an industry leader in Life Safety products?



Contact your local SSG Texas Sales Representative for more information or to obtain pricing on any of these product lines.





Quick Ship Wood Doors and Prefinished Steel Frames Now Available from SSG Texas!



You've trusted SSG Texas for your quick ship hollow metal and hardware needs for years.
Now, we are proud to announce the same great service for wood doors!

Although not physically stocked at the SSG Texas warehouses,
our wood doors are available for quick ship in as little as 3 days!
(some restrictions apply...please ask!)

Flush Architectural Grade Doors - Red Oak & Birch,
7 Ply & 5 Ply in 20, 60 & 90 Min. Available up to 3090 & 4080

Flush Residential Grade Doors - Hollow Core & Solid Core
w/ 20 Min. Available for Most Solid Cores 6'8" & 7' Heights

Molded Panel Doors - Both Hollow Core & Solid Core
w/ 20 Min. Available in Both Textured & Smooth 6 Panel Doors

Prefinished Residential Grade Doors

Residential Grade Steel & Fiberglass Doors

Stile & Rail Doors Available in Primed, Fir, Oak, Maple, Cherry, Mahogany
& Other Species As Well As Panel Doors & French Doors

Many Sizes & Styles Available With Wide Stiles for Commercial Hardware

Wood Door Rabbited Frames and Flat Jambs
Available for Various Wall Thicknesses & Door Sizes
20 Min. Wood Jambs & Frame Available

Hinged & Sliding Patio Door Systems Available in Wood,
Clad Wood, Steel & Fiberglass

Wood, Aluminum & Vinyl Windows Available

Wood Screen Doors Available

Columns Available in Wood & Fiberglass

Wood Trim & Door Casing in MDF, Primed Wood,
Fingerjoint Pine & Hardwoods
Prehanging & Assembly of Wood, Steel &
Fiberglass Door Units

Special Door Sizing for Width & Height

Complete Custom Door & Frame Manufacturing

Fire Labeling of 20, 45, 60 & 90 Min.

Machining of Wood Doors for use with Metal Frames

Finishing & Painting of Wood Doors & Frames

Fabrication of Entrance Systems - Both Interior & Exterior

Coordination of Doors, Frames & Hardware

Worldwide Packing, Crating & Shipping of all Products



For More Information or Pricing,
Please Contact Your Local
SSG Texas Representative

Greg Shuck - SSG Texas
2020 Exchange Drive, Arlington, TX 76011
Toll Free 1-855-738-3835
www.ssg-texas.com gregshuck@ssg-texas.com



(Min. Order \$50 or \$9 Service Charge Added)



MAKE ALL PURCHASE ORDERS OUT TO CAL-ROYAL PRODUCTS

PRICING IS LIST PRICE

Additional designs, functions, finishes IC Core and additional keyways stocked at California warehouse. Keying other than KD or KA (Keyed-Alike) must be ordered from California warehouse.

(Minimum Order \$50 or \$8 Service Charge Added)



Grade 1 Cylindrical Leversets



*** Stocked in DFW and Houston**

GENESYS CGN SERIES



- Heavy Duty
- Hurricane Approved (FL13922)
- Clutch Mechanism
- Fixed Thru Bolt Installation
- 3 1/2" Rose
- 1 3/8" to 1 3/4" Door
- ASA Strike
- Schlage "C" Keyway

ITEM	DESCRIPTION	US26D LIST PRICE	US10B LIST PRICE
CGN-00	ENTRANCE	\$204.68	\$215.09
CGN-03	CLASSROOM	\$211.62	\$222.01
CGN04	COMMUNICATING (KEYED DOUBLE CYLINDER)	\$242.81	\$253.20
CGN-05	STOREROOM	\$204.68	\$215.90
CGN-06	VESTIBULE	\$242.81	\$253.20
CGN-07	CLASSROOM INTRUDER	\$242.81	NON STOCK
CGN-09	INSTITUTION (KEYED DOUBLE CYLINDER)	\$242.81	\$253.20
CGN-20	PRIVACY	\$190.76	\$197.76
GN-30	PASSAGE	\$156.12	\$166.51
GN-40	SINGLE DUMMY	\$52.04	\$55.50
ICCGN-00	ENTRANCE with IC Core	\$204.68	\$215.09
ICCGN-03	CLASSROOM with IC Core	\$211.62	\$222.01
ICCGN-05	STOREROOM with IC Core	\$204.68	\$215.09
GND238	DEAD LATCH 2-3/8"	\$15.62	\$15.62



MAKE ALL PURCHASE ORDERS OUT TO CAL-ROYAL PRODUCTS

PRICING IS LIST PRICE

Additional designs, functions, finishes IC Core and additional keyways stocked at California warehouse. Keying other than KD or KA (Keyed-Alike) must be ordered from California warehouse.
(Minimum Order \$50 or \$8 Service Charge Added)



Grade 2 Cylindrical Leversets

*** Stocked in DFW
and Houston**

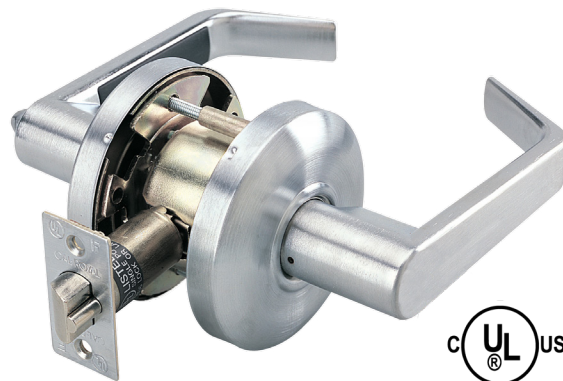

- Heavy Duty
- Fixed Thru Bolt Installation
- Hurricane Approved (FL13922)
- 3-5/16" Rose
- 1 3/8" to 1 3/4" Door
- ASA Strike
- Schlage "C" Keyway



PIONEER SL SERIES

ITEM	DESCRIPTION	US26D LIST PRICE	US10BE LIST PRICE
SL00	ENTRANCE	\$105.73	\$109.62
SL01	ENTRANCE PUSH BUTTON	\$105.73	\$109.62
CSL00	CLUTCHING ENTRANCE	\$118.72	\$122.61
SL03	CLASSROOM	\$105.73	\$109.62
SL05	STOREROOM	\$105.73	\$109.62
SL20	PRIVACY	\$87.83	\$92.73
SL30	PASSAGE	\$84.58	\$89.48
SL40	SINGLE DUMMY	\$29.30	\$32.55
SL50	EXIT	\$85.65	\$93.14
ULSLD238	DEAD LATCH 2-3/8"	\$15.62	\$15.62
ULSLS238	SPRING LATCH 2-3/8"	\$15.62	\$15.62
ICSL00	ENTRANCE with IC Core	\$105.73	\$109.62
ICSL05	STOREROOM with IC Core	\$105.73	\$109.62
ICSL03	CLASSROOM with IC Core	\$105.73	\$109.62
6PUC	6 PIN NON-KEYED CORES	\$20.41 LIST	
7PUC	7 PIN NON-KEYED CORES	\$20.41 LIST	



EXPLORER XP SERIES

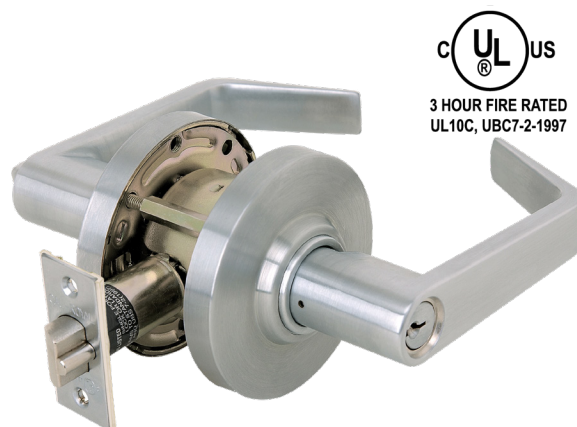

- Heavy Duty
- 3-5/16" Rose
- 1 3/8" to 1 3/4" Door
- ASA Strike
- Schlage "C" Keyway
- Optional Thru Bolt Installation

ITEM	DESCRIPTION	US26D LIST PRICE	US10BE LIST PRICE
XP00	ENTRANCE	\$105.73	\$109.62
XP03	CLASSROOM	\$105.73	\$109.62
XP05	STOREROOM	\$105.73	\$109.62
XP20	PRIVACY	\$87.83	\$92.73
XP30	PASSAGE	\$87.58	\$89.48
XP40	SINGLE DUMMY	\$29.30	\$32.55
XP50	EXIT	\$85.65	\$93.14

Backsets: UL listed 2 3/8", (2 1/4" x 1") faceplate, **NO EXTRA CHARGE** if ordered with lock only. Otherwise \$11.91 **List Each**.

PARTS AND ACCESSORIES (XP Series)			
ULSLD238	UL DEAD LATCH 2-3/8"	\$12.40	\$15.62
ULSLS238	UL SPRING LATCH	\$12.40	\$15.62

MAKE ALL PURCHASE ORDERS OUT TO CAL-ROYAL PRODUCTS

PRICING IS LIST PRICE

Additional designs, functions, finishes IC Core and additional keyways stocked at California warehouse. Keying other than KD or KA (Keyed-Alike) must be ordered from California warehouse.

(Minimum Order \$50 or \$8 Service Charge Added)



Grade 2 Cylindrical Leversets

*** Stocked in DFW and Houston**

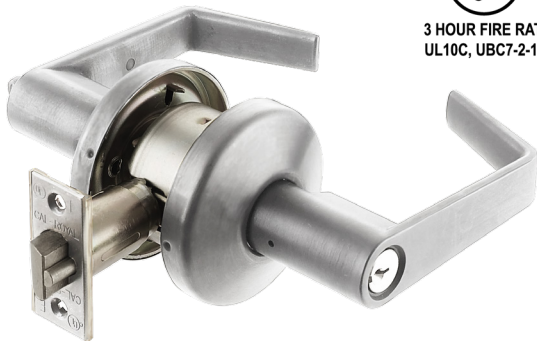

CHALLENGER SG SERIES

- Standard Duty
- Optional Thru Bolt Installation
- 3" Rose
- 1 3/8" to 1 3/4" Door
- ASA Strike
- Schlage "C" Keyway

ITEM	DESCRIPTION	US26D LIST PRICE
SG00	ENTRANCE	\$85.34
SG03	CLASSROOM	\$85.34
SG05	STOREROOM	\$85.34
SG20	PRIVACY	\$69.81
SG30	PASSAGE	\$68.31
SG40	SINGLE DUMMY	\$34.12
SG50	EXIT	\$68.31
ULHIL238	2-3/8" DEAD LATCH (key functions only)	\$15.62
ULSLS238	2-3/8" SPRING LATCH (for privacy only)	\$15.62
ULSHIL238	2-3/8" SPRNG LATCH (for passage only)	\$15.62

Grade 2 Cylindrical Knobsets



BARRINGTON BA SERIES

- Standard Duty
- 3" Rose
- 1 3/8" to 1 3/4" Door Thickness
- ASA Strike
- Schlage "C" Keyway

ITEM	DESCRIPTION	US32D LIST PRICE
TBA00	ENTRANCE	\$48.07
BA03	CLASSROOM	\$55.38
BA05	STOREROOM	\$48.07
BA20	PRIVACY	\$34.97
BA30	PASSAGE	\$32.06
BA40	SINGLE DUMMY	\$15.76

Backsets: UL listed 2 3/8", (2 1/4" x 1") faceplate, **NO EXTRA CHARGE** if ordered with lock only. Otherwise \$11.91 **List Each**.



MAKE ALL PURCHASE ORDERS OUT TO CAL-ROYAL PRODUCTS

PRICING IS LIST PRICE

Additional designs, functions, finishes IC Core and additional keyways stocked at California warehouse. Keying other than KD or KA (Keyed-Alike) must be ordered from California warehouse.

(Minimum Order \$50 or \$8 Service Charge Added)



**Grade 1
Heavy Duty Deadbolts**

*** Stocked in DFW and Houston**



CRB800 SERIES

ITEM	DESCRIPTION	US26D LIST PRICE	US10B LIST PRICE
CRB800	SINGLE CYLINDER DEADBOLT	\$93.12	\$95.89
CRB700	DOUBLE CYLINDER DEADBOLT	\$116.74	\$119.51



- Maximum Heavy Duty
- Available with Interchangeable Core
- 1 3/8" to 2" Door Thickness
- Adjustable UL Listed 3 Hour Fire Rating
- Schlage "C" Keyway

**Grade 2
Standard Duty Deadbolts**



*** Stocked in DFW and Houston**

CB160 SERIES

ITEM	DESCRIPTION	US26D LIST PRICE	US10B LIST PRICE
CB160	SINGLE CYLINDER DEADBOLT	\$44.30	\$46.90



- Standard Duty
- Wrought Brass or Stainless Steel Trim
- 1 3/8" to 1 3/4" Door Thickness
- Adjustable backset 2 3/8" - 2 3/4"
- Schlage "C" Keyway



MAKE ALL PURCHASE ORDERS OUT TO CAL-ROYAL PRODUCTS

PRICING IS LIST PRICE

Additional designs, functions, finishes IC Core and additional keyways stocked at California warehouse. Keying other than KD or KA (Keyed-Alike) must be ordered from California warehouse.

(Minimum Order \$50 or \$8 Service Charge Added)



**Grade 2
Heavy Duty Deadbolts**



T300 SERIES

ITEM	DESCRIPTION	US26D LIST PRICE	US10B LIST PRICE
ULT360	SINGLE CYLINDER DEADBOLT	\$60.29	\$64.76
ICULT360	SINGLE CYLINDER DEADBOLT W/ IC CORE	\$62.44	\$66.84

- Heavy Duty
- Wrought Brass or Stainless Steel Trim
- 1 3/8" to 1 3/4" Door Thickness
- Adjustable backset 2 3/8" - 2 3/4"
- Schlage "C" Keyway

**Grade 3
Standard Duty Deadbolts**



T220 SERIES

ITEM	DESCRIPTION	US26D LIST PRICE	US10B LIST PRICE
T220	SINGLE CYLINDER DEADBOLT	\$37.80	\$40.45
T330	DOUBLE CYLINDER DEADBOLT	\$50.40	\$53.05

- Standard Duty
- Wrought Brass or Stainless Steel Trim
- 1 3/8" to 1 3/4" Door Thickness
- Adjustable backset 2 3/8" - 2 3/4"
- Schlage "C" Keyway

MAKE ALL PURCHASE ORDERS OUT TO CAL-ROYAL PRODUCTS

PRICING IS LIST PRICE

Additional designs, functions, finishes IC Core and additional keyways stocked at California warehouse. Keying other than KD or KA (Keyed-Alike) must be ordered from California warehouse.
 (Minimum Order \$50 or \$8 Service Charge Added)



Grade 1 Door Closers

*** Stocked in DFW and Houston**



UL US
 3 HOUR FIRE RATED
 UL10C, UBC7-2-1997

MEETS
The Buy American Act

Lifetime
 Warranty

BHMA
 CERTIFIED
Be Safe. Be Secure. Look for the Mark.

900 SERIES

ITEM	DESCRIPTION	ALUM	DURO
N900PBF	BARRIER FREE, ADJUSTABLE 1-6	\$157.38	\$157.38
PARTS AND ACCESSORIES			
HOSRPS/900	SUPER RIGID PARALLEL ARM STOPPER HOLD-OPEN	\$70.89	\$70.89
SPAS900	SUPER RIGID PARALLEL ARM STOPPER NON-HANDED	\$63.79	\$63.79
950	FLAT DROP BRACKET	\$21.29	\$21.29



UL US
 3 HOUR FIRE RATED
 UL10C, UBC7-2-1997

Lifetime
 Warranty

BHMA
 CERTIFIED
Be Safe. Be Secure. Look for the Mark.

CR441 SERIES

ITEM	DESCRIPTION	ALUM	DURO
CR441	BARRIER FREE, ADJUSTABLE 1-6 (EQUAL TO LCN 4041)	\$231.74	\$231.74
PARTS AND ACCESSORIES			
CR3077SPAS	SUPER RIGID PARALLEL ARM STOPPER NON-HANDED (EQUIVALENT TO LCN CUSH-N-STOP (CUSH) ARM)	\$63.79	\$63.79
CR3049HOSRPS	SUPER RIGID PARALLEL ARM STOPPER NON-HANDED.EQUIVALENT TO LCN HOLD-OPEN (H-CUSH) ARM	\$70.78	\$70.78
CR18PA	DROP PLATE FOR PARALLEL ARM MOUNTING TOP RAIL	\$36.70	\$36.70

MAKE ALL PURCHASE ORDERS OUT TO CAL-ROYAL PRODUCTS

PRICING IS LIST PRICE

Additional arms, plated and painted finishes available from the California warehouse.



(Minimum Order \$50 or \$8 Service Charge Added)

Grade 1 Door Closers

*** Stocked in DFW and Houston**



3 HOUR FIRE RATED
UL10C, UBC7-2-1997

300 SERIES

Lifetime Warranty

ITEM	DESCRIPTION	ALUM DURO
300PCOV	ADJUSTABLE 3-6 (EXTERIOR) FULL COVER	\$116.91
300PBFCOV	ADJUSTABLE 1-4 (INTERIOR) FULL COVER	\$116.92
PARTS AND ACCESSORIES		
301/302	HOLD OPEN ARM AND PARALLEL BRACKET	\$30.84
704	FLAT DROP BRACKET	\$17.74

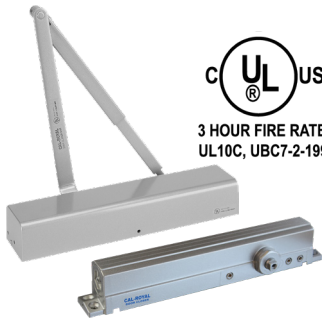

3 HOUR FIRE RATED
UL10C, UBC7-2-1997

CR801 SERIES

Lifetime
Warranty



ITEM	DESCRIPTION	ALUM	DURO
CR801	ADJUSTABLE 1-6 (EXTERIOR/INTERIOR) FULL COVER	\$136.24	\$160.93



3 HOUR FIRE RATED
UL10C, UBC7-2-1997

500 SERIES

Lifetime Warranty

ITEM	DESCRIPTION	ALUM DURO
500-PBF	ADJUSTABLE 1-5 WITH BACK CHECK (NO COVER)	\$110.45
PARTS AND ACCESSORIES		
500COV	SLIM PLASTIC COVER	\$9.55
501/502	HOLD OPEN ARM AND PARALLEL BRACKET	\$30.84
704	FLAT DROP BRACKET	\$17.74

MAKE ALL PURCHASE ORDERS OUT TO CAL-ROYAL PRODUCTS

PRICING IS LIST PRICE



(Minimum Order \$50 or \$8 Service Charge Added)

88 SERIES

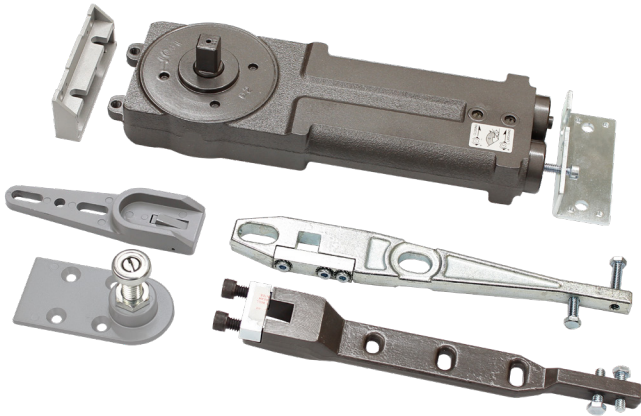

- **Power Adjustable 1-4 (Grade 1)**
- **Meets both 5 and 8.5 lbs opening force for ADA**
- **Replacement for International, Calibre, and CR Laurence**

FEATURES

- ANSI A156.4 **Grade 1**: UL Listed
- Cal-Royal's finest concealed overhead door closer series meeting the highest industry standards **Grade 1**.
- UL Listed for **fixed** size door closers. (**Grade 1**)
UL Listed 10c for **adjustable** door closers. (**Grade 1**)
- **Center Hung Door Application:** Double or Single Acting (applied door stop renders unit Single Acting). Adjustable "S" type side loading or "A" type, "K" type, and "PT" type end loading arms are available for center pivoted door applications.
- **Offset Hung Door Application:** Single Acting Offset "JO" and "VO" type top arms are available for butt hung or offset pivoted applications.
- Available with 1/2", 3/4" long, and 7/8" extended spindles.

FUNCTIONS

- Built-in positive Back Stop and Hold-Open positions are available:

- 105° Back Stop with Hold-Open
- 105° Back Stop - no Hold-Open
- 90° Back Stop with Hold-Open
- 90° Back Stop - no Hold-Open

- Handicap (ADA) adjustable spring tensions available for use on center pivoted door applications:

- Available also in **light, medium, heavy** standard Fixed Spring Tensions

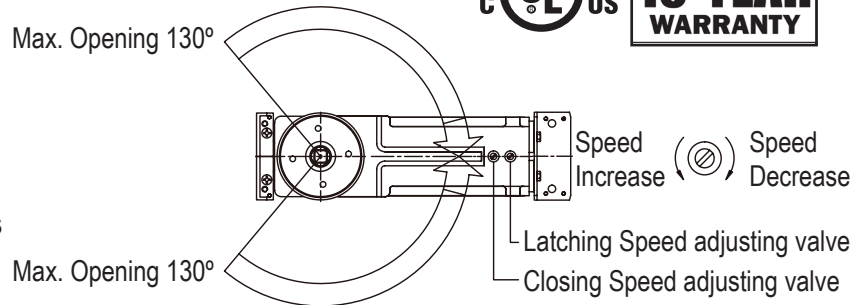

5.0 lb. Opening Force (Center Hung Door)
8.5 lb. Opening Force (Center Hung Door)

POWER SIZE	1	2	3	4
Max Door width [inches (mm)]	31 1/2 (800)	35 7/16 (900)	39 3/8 (1000)	43 5/16 (1100)
Max Door weight [lbs (kg)]	220 (100)			

List Prices

POWER SIZE	SPINDLE	OPENING	ITEM #	LIST PRICE (BODY ONLY)
Adjustable 1 - 4, ADA 5 lbs (Interior) ADA 8.5 lbs (Exterior)	1/2"	105° NHO	8830	\$151.20



MAKE ALL PURCHASE ORDERS OUT TO CAL-ROYAL PRODUCTS

PRICING IS LIST PRICE

Additional sizes, finishes, trim designs, IC Core and additional keyways stocked at California warehouse. Keying other than KD or KA (Keyed-Alike) must be ordered from California warehouse.

(Minimum Order \$50 or \$8 Service Charge Added)



**Grade 1
EXIT DEVICES**



***Stocked in DFW and Houston**



9800 SERIES

ITEM	DESCRIPTION	US32D	US10B
A9800EO36	RIM EXIT FOR DOORS 36" WIDE	\$456.52	\$508.86
AF9800EO36	FIRE RATED RIM EXIT FOR DOORS 36" WIDE	\$536.97	\$593.13
TRIMS AND ACCESSORIES		US26D	US10B
9800NL	NIGHT LATCH PULL WITH CYLINDER	\$117.94	\$117.94
9800DTP	DUMMY TRIM PULL	\$92.94	\$92.94
98TP00	ENTRANCE THUMBPIECE TRIM	\$176.90	\$176.90
ENT00L	ENTRANCE LEVER TRIM	\$153.60	\$153.60
ICENT00L	BEST, FALCON, SFIC CLUTCH ENTRANCE	\$153.60	\$153.60
STR05L	STOREROOM LEVER TRIM	\$153.60	\$153.60
PAS30L	PASSAGE LEVER TRIM	\$153.60	\$153.60
NESC9800	RIGID ENTRANCE	\$192.38	\$192.38
NESC9805	RIGID STOREROOM ALWAYS LOCKED	\$192.38	\$192.38
NESC9830	ESCUTCHEON TRIM CLUTCH PASSAGE	\$192.38	\$192.38
HDESC-00	HEAVY DUTY ,CLUTCH ENTRANCE	\$302.54	-
ICHDESC-00	BEST, FALCON, SFIC CLUTCH ENTRANCE	\$302.54	-



***Stocked in DFW and Houston**



7700 SERIES

ITEM	DESCRIPTION	US32D	US10B
A7700EO36	RIM EXIT FOR DOORS 36" WIDE	\$582.11	\$582.11
AF7700EO36	FIRE RATED RIM EXIT FOR DOORS 36" WIDE	\$683.66	\$683.66
A7760V3684	SURFACE VERTICAL ROD 36" X 84" **SH	\$761.79	-
TRIMS AND ACCESSORIES		US26D	US10B
ENT00L	ENTRANCE LEVER TRIM	\$153.60	\$153.60
ICENT00L	BEST, FALCON, SFIC CLUTCH ENTRANCE	\$153.60	\$153.60
STR05L	STOREROOM LEVER TRIM	\$153.60	\$153.60
PAS30L	PASSAGE LEVER TRIM	\$153.60	\$153.60
ESC7700	ENTRANCE ESCUTCHEON TRIM	\$192.38	\$192.38
ESC7705	STOREROOM FUNCTION ESCUTCHEON TRIM	\$192.38	\$192.38
ESC7730	ESCUTCHEON TRIM CLUTCH PASSAGE	\$192.38	\$192.38
7700NL	NIGHT LATCH PULL WITH CYLINDER	\$117.94	\$117.94
7700DTP	DUMMY TRIM PULL	\$92.92	\$92.92
HDESC-00	HEAVY DUTY ,CLUTCH ENTRANCE	\$302.54	-
ICHDESC-00	BEST, FALCON, SFIC CLUTCH ENTRANCE	\$302.54	-

MAKE ALL PURCHASE ORDERS OUT TO CAL-ROYAL PRODUCTS

PRICING IS LIST PRICE



(Minimum Order \$50 or \$8 Service Charge Added)

MULLIONS / EXTENSION RODS

ITEM	DESCRIPTION	PRIME COATED
424	SQUARE STEEL MULLION FIRE RATED APPLICATION	\$390.66
418	REMOVABLE ALUMINUM MULLION (NON RATED)	\$326.30
LCKUL424	LOCKABLE, UL-LISTED FIRE EXIT MULLION	\$636.83
ROD96 ALUM	ROD ONLY, FOR EXIT DEVICE 96" HIGH	\$33.17
VRRD10 ALUM	VERTICAL ROD FOR 10 FT. DOORS	\$33.17

ELECTRONIC LOCK

ITEM	DESCRIPTION	US26D
CR3000	HEAVY DUTY GRADE 1 DIGITAL KEYPAD LOCK	\$699.80



CRCODE200 SERIES

Grade 2, Mechanical Stand Alone Push Button Lock and Exit Device Trim with **BREAKAWAY LEVER FEATURE**



CRCODE202

Standard (Storeroom Function)
Optional (Passage Mode)



CRCODE204 Universal Trim

2200, 6600, 7700 and 9800 Series Rim and Surface Vertical Rods
Standard (Storeroom Function) Optional (Passage Mode)

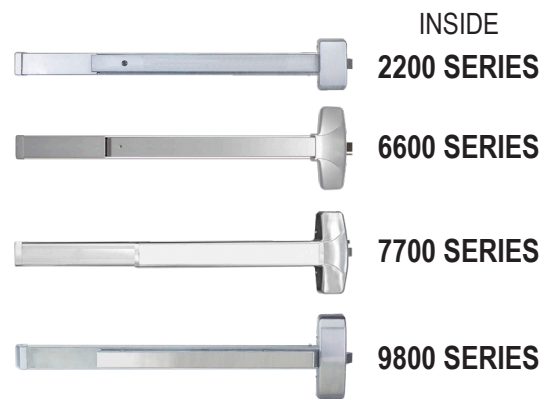

FUNCTION	ITEM #	US26D
Mechanical Easy Code Change Lock with 2 3/4" backset latchbolt Door Thickness: 1 3/8" - 2 1/4"	CRCODE202	\$451.11
Mechanical Easy Code Change Exit Trim for 2200, 6600, 7700 and 9800 Series Exit Devices. Door Thickness: 1 3/4" - 2"	CRCODE204	\$391.40



MAKE ALL PURCHASE ORDERS OUT TO CAL-ROYAL PRODUCTS

PRICING IS LIST PRICE

Additional sizes, finishes, trim designs, IC Core and additional keyways stocked at California warehouse. Keying other than KD or KA (Keyed-Alike) must be ordered from California warehouse.
(Minimum Order \$50 or \$8 Service Charge Added)



**Grade 1
EXIT DEVICES**

*** Stocked in DFW and Houston**



MEETS
The Buy American Act

Lifetime
Warranty

BHMA
CERTIFIED
Be Safe. Be Secure. Look for the Mark.

UL US
3 HOUR FIRE RATED
UL10C, UBC7-2-1997

2200 SERIES

ITEM	DESCRIPTION	ALUM LIST PRICE	DURO LIST PRICE
A2200EO36	RIM EXIT FOR DOORS 36" WIDE	\$212.17	\$212.17
A2220EO48	RIM EXIT ONLY FOR DOORS 48" WIDE	\$222.44	-
A2260V3684	SURFACE VERTICAL ROD 36" X 84" **SH	\$342.39	\$342.39
AF2200EO36	FIRE RATED RIM EXIT FOR DOORS 36" WIDE	\$292.68	\$292.68
AF2260V3684	FIRE RATED SURFACE VERTICAL ROD 36" X 84" **SH	\$456.52	-
TRIMS AND ACCESSORIES			
2200NL	NIGHT LATCH PULL WITH CYLINDER	\$73.71	\$73.71
2200DTP	DUMMY TRIM PULL	\$38.34	\$38.34
NESC2200	RIGID ENTRANCE ESCUTCHEON TRIM	\$161.89	\$161.89
NESC2205	RIGID STOREROOM ESCUTCHEON TRIM ALWAYS LOCKED	\$161.89	\$161.89
NESC2230	PASSAGE ESCUTCHEON TRIM	\$161.89	\$161.89
		US26D	US10B
ENT00L	ENTRANCE LEVER TRIM	\$153.60	\$153.60
ICENT00L	BEST, FALCON, SFIC CLUTCH ENTRANCE	\$153.60	\$153.60
STR05L	STOREROOM LEVER TRIM	\$153.60	\$153.60
PAS30L	PASSAGE LEVER TRIM	\$153.60	\$153.60

**Grade 2
EXIT DEVICES
5000 SERIES**

*** Stocked in DFW and Houston**



UL US
3 HOUR FIRE RATED
UL10C, UBC7-2-1997

ITEM	DESCRIPTION	ALUM LIST PRICE	US32D LIST PRICE
5000EO36	RIM EXIT FOR DOORS 36" WIDE	\$160.18	\$233.30
5500EO48	RIM EXIT ONLY FOR DOORS 48" WIDE	\$168.15	-
T5000V3684	SURFACE VERTICAL ROD 36" X 84" **SH	\$329.07	-
F5000EO36	FIRE RATED RIM EXIT FOR DOORS 36" WIDE	\$215.34	-
TF5000V3684	FIRE RATED SURFACE VERTICAL ROD 36" X 84" **SH	\$424.25	-
TRIMS AND ACCESSORIES		US26D	ALUM
CLU6000L	LEVER KEYLOCK, "C" KEYWAY WITH CLUTCH	\$120.43	-
5000EOP	COVER PLATE	-	\$22.58
5000NL	NIGHT LATCH PULL WITH CYLINDER	-	\$59.07
5000DTP	DUMMY TRIM PULL	-	\$22.58
8000L	RIGID ENTRANCE CYLINDRICAL TRIM	\$102.59	-
8000S	RIGID STOREROOM CYLINDRICAL TRIM ALWAYS LOCKED	\$109.38	-
8000PAS	PASSAGE CYLINDRICAL TRIM	\$87.24	-



MAKE ALL PURCHASE ORDERS OUT TO CAL-ROYAL PRODUCTS

PRICING IS LIST PRICE

Additional sizes, styles and finishes stocked at California warehouse.



(Minimum Order \$50 or \$8 Service Charge Added)

HINGES

*** Stocked in DFW and Houston**



TBH30



BB31



BB5200



NEWSH140

PLAIN BEARING HINGES

ITEM	DESCRIPTION				LIST PRICE EA.
TBH30	4-1/2" X 4-1/2" STANDARD WEIGHT, PLAIN BEARING HINGES				
US10B	US26D	NRP US26D	USP	NRP USP	
\$9.01	\$6.52	\$7.50	\$4.91	\$6.42	

BALL BEARING HINGES

ITEM	DESCRIPTION					LIST PRICE EA.
BB31	4-1/2" X 4-1/2" STANDARD WEIGHT, BALL BEARING HINGES					
US10B	NRP US10B	US26D	NRP US26D	NRP US32D	USP	NRP USP
\$13.25	\$14.23	\$7.81	\$8.99	\$28.27	\$7.00	\$7.98

ITEM	DESCRIPTION	LIST PRICE EA.
BB5200 NRP US26D	4-1/2" X 4-1/2" HEAVY WEIGHT ,BALL BEARING HINGES	\$23.70

STANDARD WEIGHT SPRING HINGES

ITEM	DESCRIPTION	LIST PRICE EA.
NEWSH140 US26D	4-1/2" X 4-1/2" STANDARD WEIGHT ,SPRING HINGES	\$19.26
NEWSH140 US32D	4-1/2" X 4-1/2" STANDARD WEIGHT ,SPRING HINGES	\$42.00

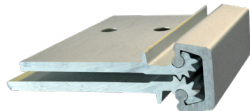

CRHD781120



CRHD781570



CRHD782100



CRHD782240

HEAVY WEIGHT CONTINUOUS HINGES

ITEM	DESCRIPTION	LIST PRICE EA.
CRHD78112083 CLR	GEARED MORTISE CONTINUOUS HINGE HEAVY DUTY 83"	\$179.04
CRHD78112083 DB	GEARED MORTISE CONTINUOUS HINGE HEAVY DUTY 83"	\$233.44
CRHD78157083 CLR	GEARED FULL SURFACE CONTINUOUS HINGE HEAVY DUTY 83"	\$226.12
CRHD78157083 DB	GEARED FULL SURFACE CONTINUOUS HINGE HEAVY DUTY 83"	\$275.71
CRHD78210083 CLR	GEARED FULL SURFACE CONTINUOUS HINGE HEAVY DUTY 83"	\$222.67
CRHD78210083 DB	GEARED FULL SURFACE CONTINUOUS HINGE HEAVY DUTY 83"	\$270.71
CRHD78210095 CLR	GEARED FULL SURFACE CONTINUOUS HINGE HEAVY DUTY 95"	\$262.86
CRHD78224083 CLR	GEARED MORTISE CONTINUOUS HINGE HEAVY DUTY 83"	\$186.98
CRHD78224095 CLR	GEARED MORTISE CONTINUOUS HINGE HEAVY DUTY 95"	\$248.17



MAKE ALL PURCHASE ORDERS OUT TO CAL-ROYAL PRODUCTS

PRICING IS LIST PRICE

Additional products, styles and finishes stocked at California warehouse.



(Minimum Order \$50 or \$8 Service Charge Added)

MISCELLANEOUS HARDWARE

*** Stocked in DFW and Houston**

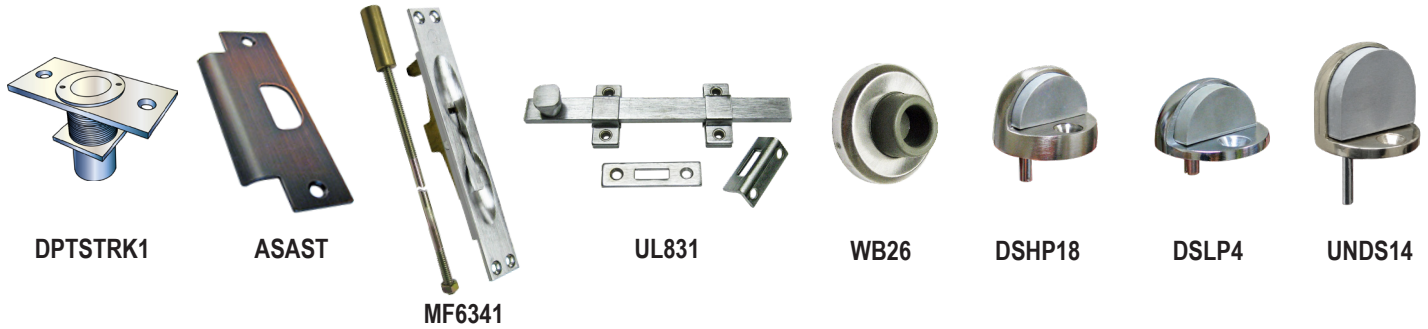

ITEM	DESCRIPTION	US26D LIST PRICE	US32D LIST PRICE	US10B LIST PRICE
MF6341	EXTENSION FLUSH BOLT COMMERCIAL	\$24.83	NON STOCK	\$25.86
UL831	HEAVYDUTY EXPOSED SCREW UL-LISTED SURFACE BOLT 8"	\$23.11	NON STOCK	NON STOCK
BKICK1034	10" X 34" KICKPLATE .050"	NON STOCK	\$54.92	\$135.89
BKICK834	8" X 34" KICK PLATE .050"	NON STOCK	\$43.66	\$108.73
BARM3436	34" X 36" STAINLESS STEEL ARMOR PLATE	NON STOCK	\$165.85	NON STOCK
1001 ADA	4" x 16" SOLID BAR ROUND PULL PLATE 3/4" DIA.	NON STOCK	\$61.44	NON STOCK
PSPL4016	PUSH PLATE SIZE 0.050" X 4" X 16"	NON STOCK	\$11.67	\$31.17
PULPL4016	PULL PLATE SIZE 0.050" X 4" X 16"	NON STOCK	\$58.66	\$97.65
DPSTRK1	BRASS DUST PROOF STRIKE	\$19.34	NON STOCK	\$19.34
ASAST	ASA STRIKE	\$2.87	NON STOCK	\$4.30
DSHP18	SOLID BRASS DOME STOP HIGH PROFILE	\$7.51	NON STOCK	\$7.51
WB26	WALL BUMPER SOLID BRASS	NON STOCK	\$3.00	\$4.10
UNDS14	UNIVERSAL LOW AND HIGH DOME STOP	\$9.26	NON STOCK	\$11.58

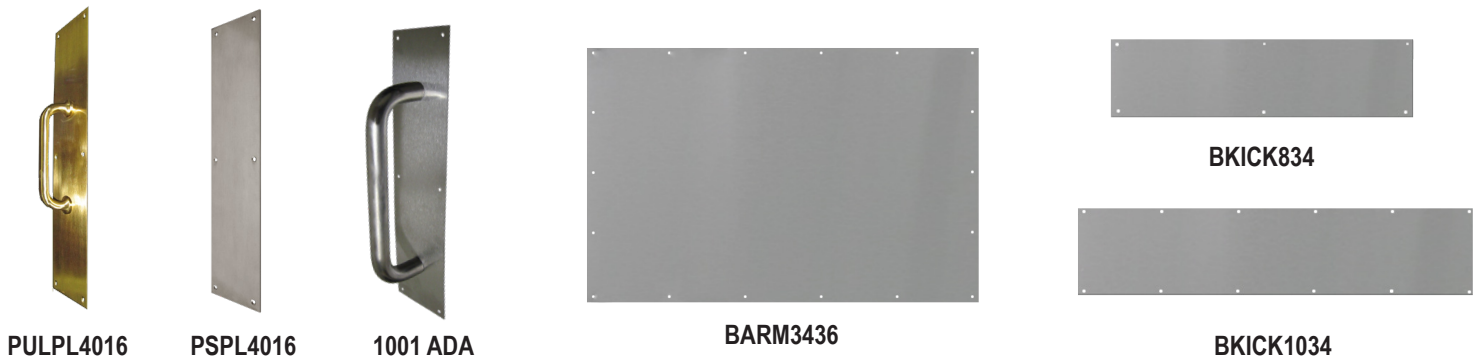

MAKE ALL PURCHASE ORDERS OUT TO CAL-ROYAL PRODUCTS

PRICING IS LIST PRICE

Additional products, styles and finishes stocked at California warehouse.



(Minimum Order \$50 or \$8 Service Charge Added)

MISCELLANEOUS HARDWARE

*** Stocked in DFW and Houston**



ULDV160



HDCDV-48



LPG2



970

ITEM	DESCRIPTION	US26D LIST PRICE	US32D LIST PRICE	US10B LIST PRICE
ULDV160	UL LISTED DOOR VIEWER 160 DEGREES	\$7.01	NON STOCK	\$7.01
HDCDV-48	HEAVY DUTY ADJUSTABLE CHAIN DOOR STOP	\$22.03	NON STOCK	NON STOCK
LPG2	LATCH GUARD PROTECTOR	ALUM \$10.63	NON STOCK	DURO \$10.63
970	SEX BOLTS FEMALE PART ONLY - 1/4" - 20 (SET OF 4)	\$5.04		

SIGNS

*** Stocked in DFW**

ITEM	DESCRIPTION	LIST PRICE
M68	MEN WITH BRAILLE PICTOGRAM TEXT	\$12.10
MH68	MEN/HANDICAP WITH BRAILLE PICTOGRAM	\$12.10
RS68	UNISEX RESTROOM WITH BRAILLE	\$12.10
RSH68	UNISEX HANDICAP RESTROOM WITH BRAILLE	\$12.10
W68	WOMEN WITH BRAILLE PICTOGRAM TEXT	\$12.10
WH68	WOMEN/BRAILLE PICTROGRAM-HANDICAP	\$12.10



M68



MH68



RS68



RSH68



W68



WH68

MAKE ALL PURCHASE ORDERS OUT TO CAL-ROYAL PRODUCTS

PRICING IS LIST PRICE

Additional products, styles and finishes stocked at California warehouse.



(Minimum Order \$50 or \$8 Service Charge Added)

BLACK ARCHITECTURAL HARDWARE

900 SERIES DOOR CLOSERS



ITEM	DESCRIPTION	LIST PRICE
N900PBF L1	BARRIER FREE, ADJUSTABLE SIZE 1-6, DOOR WEIGHTS 30-260LBS INTERIOR & EXTERIOR, FULL COVER	\$180.99
901/902 L1	HOLD-OPEN ARM WITH PARALLEL BRACKET	\$57.09
CR3049HO L1	NON-HANDED HOLD-OPEN ARM WITH PARALLEL BRACKET	\$81.52

PIONEER SL SERIES HEAVY DUTY CYLINDRICAL LEVERSETS

ITEM	DESCRIPTION	LIST PRICE
SL-00 US1	ENTRANCE	\$109.62
ICSL-00 US1	ENTRANCE, IC	\$109.62
SL-05 US1	STOREROOM	\$109.62
ICSL-05 US1	STOREROOM, IC	\$109.62
SL-03 US1	CLASSROOM	\$109.62
ICSL-03 US1	CLASSROOM, IC	\$109.62
SL-01 US1	ENTRANCE PUSH BUTTON	\$109.62
ICSL-01 US1	ENTRANCE PUSH BUTTON, IC	\$109.62
SL-20 US1	PRIVACY	\$92.73
SL-30 US1	PASSAGE	\$89.48
SL-40 US1	DUMMY	\$32.55
SL-50 US1	EXIT	\$93.14



MAKE ALL PURCHASE ORDERS OUT TO CAL-ROYAL PRODUCTS

PRICING IS LIST PRICE

Additional products, styles and finishes stocked at California warehouse.



(Minimum Order \$50 or \$8 Service Charge Added)

BLACK ARCHITECTURAL HARDWARE



ULT360



T220

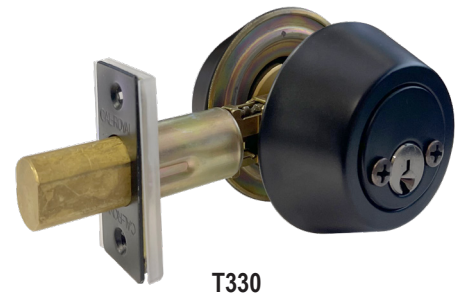

T330

DEADBOLTS

ITEM	DESCRIPTION	LIST PRICE
ULT360 US1	HEAVY DUTY SINGLE CYLINDER DEADBOLT, UL LISTED	\$64.76
T220 US1	STANDARD DUTY SINGLE CYLINDER DEADBOLT	\$40.45
T330 US1	STANDARD DUTY DOUBLE CYLINDER DEADBOLT	\$53.05



9800 SERIES EXIT DEVICE

ITEM	DESCRIPTION	LIST PRICE
A9800EO36 L1	RIM EXIT FOR DOORS 36" WIDE	\$560.01
AF9800EO36 L1	FIRE RATED RIM EXIT FOR DOORS 36" WIDE	\$653.36
ACCESSORIES		
ENT00L US1	ENTRANCE LEVER TRIM	\$153.60
STR05L US1	STOREROOM LEVER TRIM	\$153.60
PAS30L US1	PASSAGE LEVER TRIM	\$153.60
DUM40L US1	DUMMY	\$153.60

MAKE ALL PURCHASE ORDERS OUT TO CAL-ROYAL PRODUCTS

PRICING IS LIST PRICE

Additional products, styles and finishes stocked at California warehouse.



(Minimum Order \$50 or \$8 Service Charge Added)

BLACK ARCHITECTURAL HARDWARE



2200 SERIES EXIT DEVICE

ITEM	DESCRIPTION	LIST PRICE
A2200EO36 L1	RIM EXIT FOR DOORS 36" WIDE	\$244.04
AF2200EO36 L1	FIRE RATED RIM EXIT FOR DOORS 36" WIDE	\$336.57
ACCESSORIES		
ENT00L US1	ENTRANCE LEVER TRIM	\$153.60
STR05L US1	STOREROOM LEVER TRIM	\$153.60
PAS30L US1	PASSAGE LEVER TRIM	\$153.60
DUM40L US1	DUMMY	\$153.60



BUILDERS HARDWARE AND HINGES

ITEM	DESCRIPTION	LIST PRICE
PSPL4016 US1	PUSH PLATE SIZE 0.050" X 4" X 16"	\$35.14
PULPL4016 US1	PULL PLATE SIZE 0.050" X 4" X 16"	\$74.57
MF6341 L1	EXTENSION FLUSH BOLT COMMERCIAL	\$25.86
WB26 US19	WALL BUMPER SOLID BRASS	\$4.10
UNDS14 US1	UNIVERSAL LOW AND HIGH DOME STOP	\$11.58
BB-31 US1	4-1/2" X 4-1/2" STANDARD WEIGHT, BALL BEARING HINGES	\$8.01

MAKE ALL PURCHASE ORDERS OUT TO CAL-ROYAL PRODUCTS

PRICING IS LIST PRICE



(Minimum Order \$50 or \$8 Service Charge Added)

LITES AND LOUVERS

*** Stocked in DFW and Houston**

SVL SERIES, VISION LITE LOW PROFILE

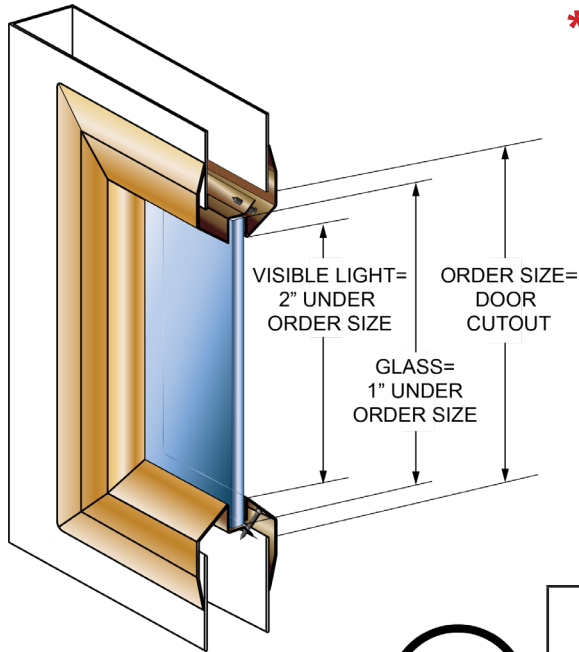

- ▶ 45-180 Minute Fire Rated Steel Vision Lites for 3/16" to 1/4" Glass
- ▶ Low Profile Beveled Vision lite for Fire Rated Doors
- ▶ Frame has Single-side Fasteners
- ▶ 20 Gauge Cold Rolled Steel
- ▶ Designed for use with 1-3/4" doors only
- ▶ Baked on powder coat finish
- ▶ Color: Standard Bronze
- ▶ Fasteners: #8 x 7/8" Flathead phillips head SMS



Intertek

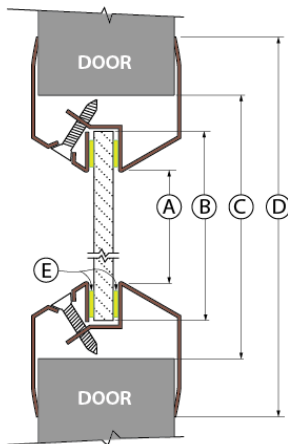

- (A) VISIBLE LIGHT = 2" UNDER ORDER SIZE
- (B) GLASS = 1" UNDER ORDER SIZE
- (C) ORDER SIZE = DOOR CUTOUT
- (D) 1-3/8" OVER ORDER SIZE
- (E) GLAZING TAPE

ITEM #	SIZE (DOOR CUTOUT) Width x Height	PCS/CTN	LIST PRICE
SVL520	5" x 20"	6	\$98.00
SVL535	5" x 35"	6	\$111.00
SVL624	6" x 24"	6	\$111.00
SVL627	6" x 27"	6	\$102.00
SVL630	6" x 30"	6	\$115.00
SVL722	7" x 22"	6	\$78.00
SVL830	8" x 30"	6	\$114.00
SVL832	8" x 32"	6	\$106.00
SVL836	8" x 36"	6	\$131.00
SVL1212	12" x 12"	10	\$62.00
SVL1818	18" x 18"	2	\$121.00
SVL2424	24" x 24"	4	\$115.00
SVL2430	24" x 30"	4	\$125.00
SVL2436	24" x 36"	2	\$136.00
SVL2460	24" x 60"	2	\$259.00
SVL2464	24" x 64"	2	\$318.00

PRICES DO NOT INCLUDE GLASS

MAKE ALL PURCHASE ORDERS OUT TO CAL-ROYAL PRODUCTS

PRICING IS LIST PRICE



(Minimum Order \$50 or \$8 Service Charge Added)

LITES AND LOUVERS

GLASS REPLACEMENTS / ACCESSORIES

*** Stocked in DFW and Houston**



Tempered Glass

- ← Heat-treated clear safety glass that breaks into small particles
- ← Light Transmission: 86% approx
- ← Thickness: 1/4" (6 mm)
- ← Non-Fire Rated

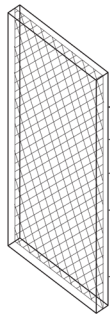

SuperLite I-W Wired Glass

- ← Embedded 3/4" x 3/4" wire mesh
- ← Light Transmission: 86% approx
- ← Thickness: 1/4" (6 mm)
- ← Annealed single glazing with safety film applied to one side
- ← 20-90 Minute Fire Rating

ITEM	DESCRIPTION	LIST PRICE
GT	Black Glazing Tape 1/16" x 3/8" x 150'	\$33.00

GLASS SIZES	WS(1/4")	TEMP (1/4")
4" x 34"	\$122.00 each	\$36.00 each
5" x 26"	\$122.00	\$36.00
6" x 21"	\$122.00	\$36.00
7" x 29"	\$176.00	--
7" x 31"	\$188.00	\$36.00
7" x 35"	\$208.00	\$36.00
11" x 11"	\$122.00	\$36.00
23" x 23"	\$447.00	\$68.00
23" x 29"	\$562.00	\$86.00
23" x 63"	\$1,257.00	\$187.00

TEMP (Tempered Glass): Heat-strengthened glass and cannot be cut after manufacturing. Fire Rating: None. Clear wire free glass recommended for non fire rated applications. Use of glazing compound or glazing tape on both sides of glass is recommended to minimize breakage.
Size: Minimum 2" x 2", max sheet size: 88" x 118".

WS (Superlite I-W Wired Glass): 20 ga CRS (Cold Rolled Steel) beveled vision lite, 1/4" wired glass with film. Glass is UL labeled standard.
Fire Rating: 20 minutes to 90 minutes. Install in fire listed and labeled vision frames. Use of glazing compound or glazing tape on both sides of glass is recommended to minimize breakage.
Size: Minimum 4" x 4", max rated size: 36" x 84".

VLV, INVERTED Y-BLADE LOUVERS

90 Minute Fire Rated Steel Louvers

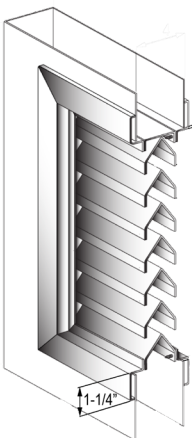
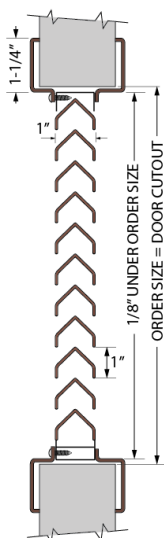

Intertek

- ▶ For use in Fire Rated door applications under positive and neutral pressure Intertek testing certification in compliance to NFPA 252 (2000), UL 10C (2009), NFPA 252 (2012), CSI CODE 089000 Louvers & Vents
- ▶ 18 Gauge cold rolled steel frame and blades
- ▶ Mitered welded corner frame construction
- ▶ Reverse "Y" blades are frame supported at 1" increments, with blocked vision design
- ▶ Single side mounting for non corridor exposure with fastening screws included
- ▶ Designed for use with 1-3/4" doors only
- ▶ Baked on powder coat finish
- ▶ Color: Standard Bronze
- ▶ Fasteners: Phillips head screws #8 x 3/4"

ITEM #	SIZE (DOOR CUTOUT)	PCS/CTN	LIST PRICE
VLV1212	12" x 12"	4	\$102.00 each
VLV1812	18" x 12"	2	\$123.00
VLV1818	18" x 18"	2	\$144.00
VLV2412	24" x 12"	2	\$143.00
VLV2418	24" x 18"	2	\$163.00
VLV2424	24" x 24"	1	\$199.00
VLV2460	24" x 60"	2	\$611.00
VLV2464	24" x 64"	2	\$638.00

MAKE ALL PURCHASE ORDERS OUT TO CAL-ROYAL PRODUCTS

PRICING IS LIST PRICE



(Minimum Order \$50 or \$8 Service Charge Added)

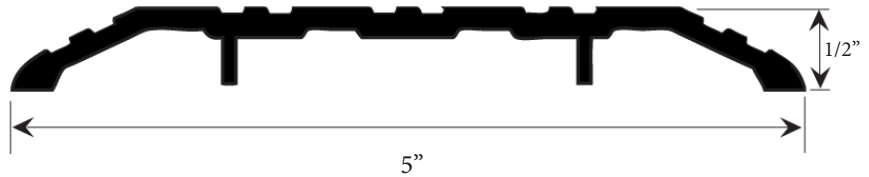
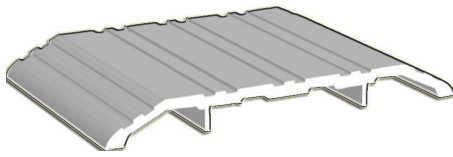

CR 2000 SERIES SADDLE THRESHOLDS

ITEM #	SIZE	FINISH	LIST PRICE PER EA. / LENGTH				PCS / MC	UNIT
			36"	48"	72"	96"		
CR2715	1/2" H x 5" W	ALUM	\$39.28	52.37	78.55	104.73	20	EACH

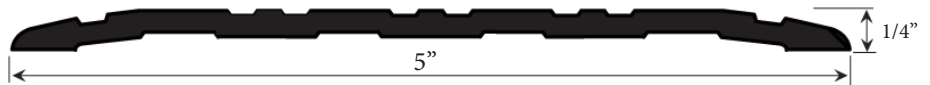
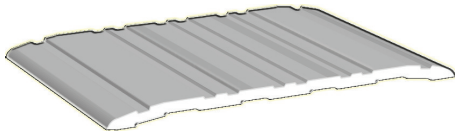

CR 3700 SERIES SADDLE THRESHOLDS

ITEM #	SIZE	FINISH	LIST PRICE PER EA. / LENGTH				PCS / MC	UNIT
			36"	48"	72"	96"		
CR3715	1/4" H x 5" W	ALUM	\$27.95	37.25	55.90	100.74	20	EACH

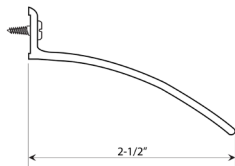
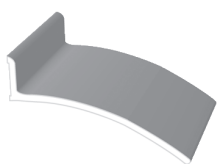

Packaging includes:
• Fasteners: #10 x 3/4" wood screws

Note: Suggested length should be 4" longer than width of door. Allow 2" distance on each end for maximum cover.

DRIP CAP

ITEM #	SIZE	FINISH	LIST PRICE PER EA. / LENGTH			PCS / MC	UNIT
			40"	52"	76"		
CR4462	2 1/2"	ALUM	\$17.93	25.89	37.84	50	EACH

PST-200

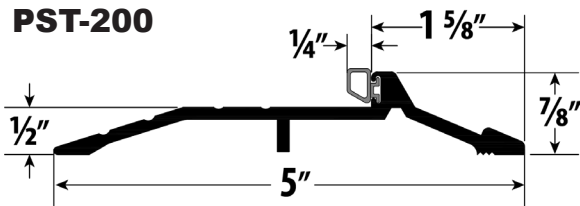

PST-201

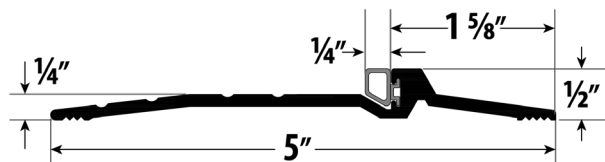

PANIC SADDLE THRESHOLDS

ITEM #	SIZE	FINISH	LIST PRICE PER EA. / LENGTH				PCS / MC	UNIT
			36"	48"	72"	96"		
PST-200	7/8" H x 5" W	ALUM	\$49.68	66.25	99.37	132.49	20	EACH
PST-201	1/2" H x 5" W		\$40.97	54.63	81.95	109.26	20	EACH

MAKE ALL PURCHASE ORDERS OUT TO CAL-ROYAL PRODUCTS

PRICING IS LIST PRICE



(Minimum Order \$50 or \$8 Service Charge Added)

DOOR BOTTOM SWEEPS

ILLUSTRATION	ITEM #	DESCRIPTION	FINISH	LIST PRICE EACH / LENGTH		PCS / MC	UNIT
				36"	48"		
	BTSR-108	Door Bottom Sweep with Rain Drip made of Extruded Aluminum Retainer and Vinyl Insert Width: 9/16" (14.3mm) Profile Height: 1 7/16" (36.6mm) Total Height: 2" (51.3mm)	AV	14.22	18.96	20	Ea.
	BTS-103	Door Bottom Sweep made of Extruded Aluminum Retainer and Vinyl Insert Width: 1/4" (6.4mm) Profile Height: 7/8" (22.2mm) Insert Height: 1" (25.4mm) Total Height: 1 7/8" (47.6mm)	AV	9.82	13.09	20	Ea.
	BTN-112	Door Bottom Sweep made of Extruded Aluminum Retainer and Vinyl Insert Width: 1/4" (6.4mm) Profile Height: 1 1/4" (31.8mm) Total Height: 1 11/16" (42.9mm)	AN	25.37	33.83	20	Ea.

Available Finishes: AV (Mill Finish Aluminum with Vinyl Insert) | DV (Dark Bronze Anodized Aluminum with Vinyl Insert)
Specify: Item # + Finish + "-" + Length when ordering. Example: BTSR-108AV-36 for BTSR-108 with AV finish in 36" length.

- Packaging includes:
- 1 unit of Door Bottom Sweep
 - #6 x 3/8" PPHSMS (Standard)

Testing/Ratings:



ADHESIVE WEATHERSTRIPS

ILLUSTRATION	ITEM #	DESCRIPTION	FINISH	LIST PRICE EACH / LENGTH		PCS / MC	UNIT
				17'	25'		
	C-880	Silicone Adhesive Weatherstrip with 3M Adhesive tape Width: 1/2" (12.7mm) Height: 1/4" (6.35mm)	B	17'	25'	10	Ea.
				28.52	42.89		
			B	204'	510'	*1	Ea.
				337.68	844.19		

- Packaging includes:
- Cleaner
 - UL sticker label
 - *1 = 1 Roll

Testing/Ratings:



NOTE:

Model C880 is fire rated UL10C, UL Sound, Smoke, Wind and BHMA Certified

MAKE ALL PURCHASE ORDERS OUT TO CAL-ROYAL PRODUCTS

PRICING IS LIST PRICE



(Minimum Order \$50 or \$8 Service Charge Added)

BRUSH WEATHERSTRIPS

ILLUSTRATION	ITEM #	DESCRIPTION	FINISH	LIST PRICE EACH / LENGTH				PCS / MC	UNIT
				36"	48"	84"	96"		
	BW-303	Nylon Brush with Extruded Aluminum Seal Retainer Width: 1/4" (6.4mm) Profile Height: 3/4" (19.1mm) Insert Height: 7/16" (10.3mm) Total Height: 1 3/16" (29.4mm)	A	\$12.19	16.25	28.44	32.50	20	Ea.
	BW-305	Nylon Brush with Extruded Aluminum Seal Retainer Width: 1/4" (6.4mm) Profile Height: 7/8" (22.2mm) Insert Height: 1" (25.4mm) Total Height: 1 7/8" (47.6mm)	A	\$20.99	27.99	-	-	20	Ea.

Packaging includes:
• 1 Unit of Brush Weatherstrip
• #6 x 5/8" PPHSMS (Standard)

Testing/Ratings:

PERIMETER GASKETING

ITEM #	IMAGE AND DESCRIPTION	FINISH	LIST PRICE EACH / LENGTH					PCS / MC	UNIT
			36" x 84"	48" x 84"	48" x 96"	72" x 84"	72" x 96"		
PG-603	 Aluminum Channel with Vinyl Insert Width: 1/4" (6.4mm) Profile Height: 7/8" (22.2mm) Total Height: 1 1/8" (28.6mm)	AV	34.11	36.12	40.13	40.13	44.14	25	Ea.

Available Finishes: AV (Mill Finish Aluminum with Vinyl Insert) | DV (Dark Bronze Anodized Aluminum with Vinyl Insert)
Specify: Item # + Finish + "-" + Length when ordering. Example: PG-603AV-3684 for PG-603 with AV finish in 36" x 84" length.

Packaging includes:
• 1 piece Jamb Header
• 1 piece Strike Jamb
• 1 piece Hinge Jamb
• #6 x 5/8" PPHSMS (Standard)

Testing/Ratings:

NOTE:
Model PG-603 is fire rated UL10C, UL Sound, Smoke, Wind and BHMA Certified



TX Warehouse Discounts

Items listed on the follow pages represent items stocked in the DFW & Houston Warehouses. Pricing is subject to change without notice.

TEXAS WAREHOUSE MULTIPLIERS	Quantity	Doors	Frames
	1-9		
	10-19		
	20+		
Pricing Subject To Change. Please Call For Current Pricing.			
PALLETES USED FOR LTL FREIGHT (one charge regardless of # pallets) ADD \$75			

MAKE ALL PURCHASE ORDERS OUT TO CAL-ROYAL PRODUCTS

PRICING IS LIST PRICE

Additional sizes and options stocked at DKS' California warehouse.



HINGE CROSS-REFERENCE CHART

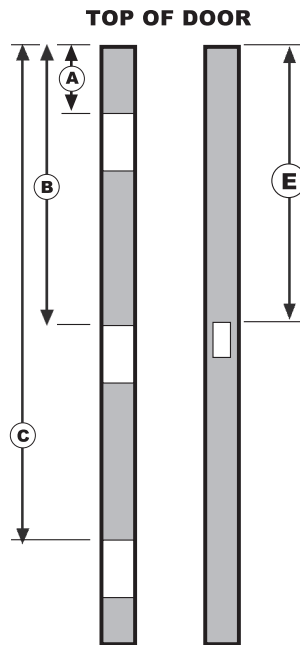

	3068 Door				3070 Door			
	A	B	C	E	A	B	C	E
DKS	7 3/8	37 5/16	67 1/4	38 7/16	7 3/8	39 5/16	71 1/4	42 7/16
Amweld	7 3/8	37 5/16	67 1/4	38 7/16	7 3/8	39 5/16	71 1/4	42 7/16
Ceco	6 5/8	37 5/8	68 5/8	36 15/16	6 5/8	39 5/8	72 5/8	40 15/16
Curries	4 7/8	35 1/8	65 3/8	38 3/4	4 7/8	37 1/8	69 3/8	42 3/4
Dean Steel	4 7/8	35 1/8	65 3/8	38 7/16	4 7/8	37 1/8	69 3/8	42 7/16
Mesker	4 7/8	35 1/8	65 3/8	38 7/16	37 1/8	37 1/8	69 3/8	42 7/16
Republic	7 3/8	37 5/16	67 1/4	38 7/16	9 3/8	39 5/16	69 1/4	42 7/16
New Republic	4 7/8	35 1/8	65 3/8	38 7/16	4 7/8	37 1/8	69 3/8	42 7/16
Steelcraft	7 3/8	37 5/16	67 1/4	38 7/16	7 3/8	39 5/16	71 1/4	42 7/16

MAKE ALL PURCHASE ORDERS OUT TO DKS

PRICING IS LIST PRICE

Additional sizes and options stocked at DKS' California warehouse.

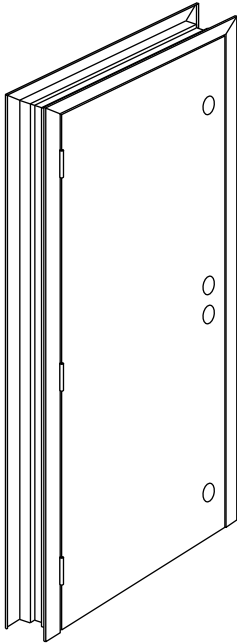
**MAX DUTY DOORS***** Stocked in DFW only**

- ◆ 14 Gauge Door
- ◆ 12 Gauge Frame
- ◆ 161 Prep & 3 Deadbolt Preps
- ◆ Polystyrene Core
- ◆ 2 3/4" Backset
- ◆ 3/8" Under-cut
- ◆ 4 1/2" x 4 1/2" Heavy Duty Hinge Prep
- ◆ DKS Steel Door & Frame Locations

MAX DUTY DOORS

Part Number	Size	Description	List Price
MD2868	2868	Max-Duty Door	\$ 894
MD3068	3068	Max-Duty Door	\$ 894

MAX DUTY FRAMES

Hand	Part Number	Size	Description	List Price
RH	MD4086	2868	5 3/4" 12 Gauge Frame w/ 3DL & ASA	\$ 539
LH	MD4087	2868	5 3/4" 12 Gauge Frame w/ 3DL & ASA	\$ 539
RH	MD4011	2868	8 3/4" 12 Gauge Frame w/ 3DL & ASA	\$ 696
LH	MD4012	2868	8 3/4" 12 Gauge Frame w/ 3DL & ASA	\$ 696

Hand	Part Number	Size	Description	List Price
RH	MD4100	3068	5 3/4" 12 Gauge Frame w/ 3DL & ASA	\$ 539
LH	MD4101	3068	5 3/4" 12 Gauge Frame w/ 3DL & ASA	\$ 539
RH	MD4800	3068	8 3/4" 12 Gauge Frame w/ 3DL & ASA	\$ 695
LH	MD4801	3068	8 3/4" 12 Gauge Frame w/ 3DL & ASA	\$ 695

PALLETS USED FOR LTL FREIGHT
(one charge regardless of # pallets) **ADD \$75**

MAKE ALL PURCHASE ORDERS OUT TO SSG TEXAS

SHOP SERVICES FOR DFW WAREHOUSE

PRICING: All Prices Listed Are Net
Prices Subject To Change Without Notice
Freight: F.O.B. Arlington
Make Purchase Orders Out To: SSG TEXAS



FRAME LABOR CHARGES

Item Code	Description	Net Price
SINGLE FRAME	WELDING SINGLE OPENING HM FRAME W/ SPREADER BARS	\$32.00
PAIRFRAME	WELDING PAIRED OPENING HM FRAME W/ SPREADER BARS	\$45.00
FLUSHSTRIKE	FLUSH BOLT PREPERATION ON HEADER	\$36.00
SINGLECLOSER	CLOSER REINFORCEMENT STANDARD OR PARALELL (SINGLE OPENING)	\$14.00
PAIRCLOSER	CLOSER REINFORCEMENT STANDARD OR PARALELL (PAIRED OPENING)	\$18.00
FPCLOSER	FULL PROFILE CLOSER REINFORCEMENT	\$36.00
BLANKOUT	BLANK OUT STRIKE	\$36.00
RIMPREP	RIM PANIC STRIKE REINFORCEMENT	\$18.00
DBSTRIKE	DEADBOLT STRIKE PREP	\$36.00
FPWELD	PUNCH & DIMPLE W/ PIPE ANCHORS	\$54.00
RETROFRAME	CUT IN AND WELD HINGE REINFORCEMENT	\$50/HINGE
STKCUTDOWN	CUT DOWN & NOTCH STICK MATERIAL	\$50.00
EXPWELD	EXPANDABLE FRAME - WELD TO CERTAIN JAMB DEPTH	\$36.00
ASTEXT	ASTRAGAL EXTENSION	\$36.00
HDSPLICE	SPLICING TWO HEADERS	\$48.00
ELECSTK	ELECTRIC STRIKE PREP	\$30.00

DOOR LABOR CHARGES

Item Code	Description	Net Price
CUTOUTSTD	VISION LITE OR LOUVER CUTOUT UP TO 24"X12"	\$40.00
CUTOUT LG	VISION LITE OR LOUVER CUTOUT LARGER THAN 24"X12"	\$50.00
CUTOUTREINFSTD	REINFORCE CUTOUT WITH DOOR CHANNEL UP TO 24"X12"	\$100.00
CUTOUTREINFLG	REINFORCE CUTOUT WITH DOOR CHANNEL LARGER THAN 24"X12"	\$150.00
TRIMPREP	PREP FOR SECTIONAL TRIM	\$36.00
RIMPREPDOOR	RIM PANIC PREP	\$36.00
DBPREPDOOR	DEADBOLT PREP	\$58.00
DOORBOUT	LOCK EDGE & FACE BLANK	\$48.00
ASTINSTALL	ASTRAGAL INSTALL	\$52.00
MBASA	CONVERT MB TO ASA	\$60.00
FLUSHDOOR	FLUSHBOLT PREP TOP & BOTTOM	\$65.00
DOORCUTDOWN	DOOR UNDERCUT (NO WELDING)	\$36.00
DRUCCHANNEL	DOOR UNDERCUT WITH WELDED IN CHANNEL	\$90.00
DRWIDTHCUTDOWN	DOOR UNDERCUT IN WIDTH WITH WELDED IN CHANNEL	\$150.00
RETRODOOR	CUT HINGES IN RETROFIT DOOR	\$78.00
PEEPSITE	PEEP HOLE PREP	\$8.00
EDGEBLANK	BLANK OUT DOOR EDGE	\$32.00

All parts/components necessary for shop labor are now included in the labor charges above



MAKE ALL PURCHASE ORDERS OUT TO DKS

PRICING IS LIST PRICE

Additional sizes and options stocked at DKS' California warehouse.



*** Stocked in DFW only**

HOLLOW METAL DOORS 18 Gauge

ITEM#	SIZE	HINGE LOCATION	PREP	STEEL	LABEL	WEIGHT LBS.	LIST PRICE
1801	2068	DKS Standard	C	CRS	WHI 3	72	\$579
1802			MB				
1810	2468	DKS Standard	C	CRS	WHI 3	78	\$579
1811			MB				
1807	2668	DKS Standard	C	CRS	WHI 3	85	\$579
1808			MB				
1825	2868	DKS Standard	C	CRS	WHI 3	89	\$579
1826			MB				
1869	21068	DKS Standard	C	CRS	WHI 3	94	\$579
1870			MB				
1813	3068	DKS Standard	C	CRS	WHI 3	99	\$579
1818			MB				
1824			BR				
CE1813	3068	Ceco	C	CRS	WHI 3	99	\$579
CE1818			MB				
DE1813		Dean Steel	C				
DE1818			MB				
CU1813		Curries	C				
CU1818			MB				
1830	3668	DKS Standard	C	CRS	WHI 3	112	\$725
1831			MB				
1832			BR				
1834	3868	DKS Standard	C	CRS	WHI 3	115	\$814
1837			MB				
1872	4068	DKS Standard	C	CRS	WHI 3	120	\$817
1873			MB				
1835	2070	DKS Standard	C	CRS	WHI 3	76	\$606
1836			MB				
1875	2470	DKS Standard	C	CRS	WHI 3		\$606
1891	2670	DKS Standard	C	CRS	WHI 3	87	\$606
1892			MB				
1894	2870	DKS Standard	C	CRS	WHI 3	92	\$606
1895			MB				
1897	21070	DKS Standard	C	CRS	WHI 3	100	\$606

Nomenclature:
 C=161
 MB=86 edge blank face
 BR=Blank Reinforced For Panic

SSG Texas can only sell doors and frames to authorized door and hardware distributors.

PALLETS USED FOR LTL FREIGHT (one charge regardless of # pallets) ADD \$75



MAKE ALL PURCHASE ORDERS OUT TO DKS

PRICING IS LIST PRICE

Additional sizes and options stocked at DKS' California warehouse.



*** Stocked in DFW only**

HOLLOW METAL DOORS 18 Gauge	ITEM#	SIZE	HINGE LOCATION	PREP	STEEL	LABEL	WEIGHT LBS.	LIST PRICE		
	1840	3070	DKS Standard	C	CRS	WHI 3	106	\$606		
	1844			MB						
	1847			BR						
	CE1840		Ceco	C						
	CE1844			MB						
	CE1847			BR						
	DE1840		Dean Steel	C						
	DE1844			MB						
	DE1847			BR						
	CU1840		Curries	C						
	CU1844			MB						
	CU1847			BR						
	REP1840		Republic	C						
	REP1844			MB						
	REP1847			BR						
	1884	3070	DKS Standard	C	Galvanized	WHI 3	107	\$631		
	1887			MB						
	1890			BR						
1863	3080	DKS Standard	C	CRS	WHI 3	118	\$817			
1862			MB							
1864			BR							
1850	3670		C			MB	119	\$744		
1849						MB				
1853	3870		C			BR	121	\$836		
1856						MB				
1854	4070		C			BR	134	\$836		
1855						MB				
1859						BR				
1865	4080		DKS Standard			C	CRS	WHI 3	120	\$1027
1866						MB				

Nomenclature:

- C=161
- MB=86 edge blank face
- BR=Blank Reinforced For Panic

SSG Texas can only sell doors and frames to authorized door and hardware distributors.

PALLETS USED FOR LTL FREIGHT
(one charge regardless of # pallets) **ADD \$75**



MAKE ALL PURCHASE ORDERS OUT TO DKS

PRICING IS LIST PRICE

Additional sizes and options stocked at DKS' California warehouse.

*** Stocked in Houston only****Hollow Metal Doors 18 Ga.**

ITEM#	SIZE	HINGE LOCATION	PREP	STEEL	LABEL	WEIGHT LBS.	LIST PRICE	
G1880	3068	DKS Standard	C	Galvanized	WHI 3	100	\$606	
G1881			MB					
G1882			BR					
CEG1813		Ceco	C					
CEG1818			MB					
G1884		3070	DKS Standard					C
G1887	MB							
G1890	BR							
CEG1840	Ceco		C					
CEG1844			MB					
CEG1847			BR					
CUG1840	Curries		C					
CUG1844			MB					
CUG1847			BR					
G1863	3080		DKS Standard			C		
G1862						MB		
G1864						BR		
G1850	3670	MB						
G1849		C						
G1853	3870	C						
G1856		BR						
G1854	4070	C						
G1855		MB						
G1859		BR						
G1865	4080	C						
G1866		MB						
REP1840	3070			C				\$267
REP1844								
REP1847	3070			BR				\$267

Nomenclature:

C=161

MB=86 edge blank face

BR=Blank Reinforced For Panic

PALLETS USED FOR LTL FREIGHT
(one charge regardless of # pallets) **ADD \$75**

**SSG Texas can only
sell doors and frames
to authorized door and
hardware distributors.**



MAKE ALL PURCHASE ORDERS OUT TO DKS

PRICING IS LIST PRICE

Additional sizes and options stocked at DKS' California warehouse.



*** Stocked in Houston only**

Hollow Metal Doors 16 Ga.

ITEM#	SIZE	HINGE LOCATION	PREP	STEEL	LABEL	WEIGHT LBS.	LIST PRICE
G1622	3068	DKS Standard	C	Galvanized	WHI 3	116	\$894
G1604	3070		C			124	\$933
G1608			MB				
G1611			BR				
G1681			3090				
G1687	3690		190			\$1886	
G1693	4090		200			\$2664	

Inactive Flush Bolt Prep H.M. Doors 18 Ga.

ITEM#	SIZE	HINGE LOCATION	HAND	PREP	STEEL	LABEL	WEIGHT LBS.	LIST PRICE
G2006LIA	3068	DKS Standard	Left	ASA/FB	Galvanized	WHI 3	106	\$900
G2006RIA			Right					
G2007LIA	3070		Left				108	\$930
G2007RIA			Right					

Continuous Hinge H.M. Doors 18 Gauge, 15/32" Undercut in Width

ITEM#	SIZE	HINGE LOCATION	PREP	STEEL	GAUGE	LABEL	WEIGHT LBS.	LIST PRICE
G1813CH	3068	N/A	C	Galvanized	18	WHI 3	102	\$659
G1840CH	3070		C				104	\$685
G1847CH			BR					
G1863CH	3080		C		119		\$973	
G1611CH	3070		BR					16

Retrofit Hollow Metal Doors 18 Ga.

ITEM#	SIZE	HINGE LOCATION	PREP	STEEL	LABEL	WEIGHT LBS.	LIST PRICE
G1524	3068	N/A	Lock Side Reinforced	Galvanized	Not Labeled	100	\$721
G1547	3070					107	\$749
G1548	4070					135	\$1037
G1564	3080					119	\$1011

Nomenclature:

- C=161
- MB=86 edge blank face
- BR=Blank Reinforced For Panic

SSG Texas can only sell doors and frames to authorized door and hardware distributors.

PALLETS USED FOR LTL FREIGHT
(one charge regardless of # pallets) **ADD \$75**



MAKE ALL PURCHASE ORDERS OUT TO DKS

PRICING IS LIST PRICE

Additional sizes and options stocked at DKS' California warehouse.

*** Stocked in Houston only****Steel Frames 4000 Series Masonry 16 Ga.**

ITEM#	SIZE	HAND	HINGE LOCATION	ASSEMBLY	DEPTH	STEEL	LABEL	WEIGHT LBS.	LIST PRICE
4108	3068	RH	DKS Standard	KD	5.75"	Galvanized	WHI 3	39	\$313
4109		LH						39	
4112	3070	RH						40	\$330
4113		LH						40	
4116	3080	RH						54	\$392
4117		LH						54	
4165	4068	RH						49	
4166		LH						49	
4167	4070	RH						50	\$328
4168		LH						50	
4118	4080	RH						55	\$403
4119		LH						55	
4505	6068	Pair						46	\$414
4511	6070	Pair						47	\$431
--	6080	Pair						52	\$501

Steel Frames 5000 Series Drywall 16 Ga.

ITEM#	SIZE	HAND	HINGE LOCATION	ASSEMBLY	DEPTH	STEEL	LABEL	WEIGHT LBS.	LIST PRICE
5200	3068	RH	DKS Standard	KD	5.875"	CRS	WHI 90	39	\$298
5201		LH						39	
5500	3070	RH						40	\$310
5501		LH						40	
5623	4068	RH						40	\$304
5624		LH						40	
5625	4070	RH						41	\$316
5626		LH						41	
5636	6068	Pair						46	\$382
5637	6070	Pair						47	\$396

SSG Texas can only sell doors and frames to authorized door and hardware distributors.

PALLETS USED FOR LTL FREIGHT
(one charge regardless of # pallets) **ADD \$75**



MAKE ALL PURCHASE ORDERS OUT TO DKS

PRICING IS LIST PRICE

Additional sizes and options stocked at DKS' California warehouse.

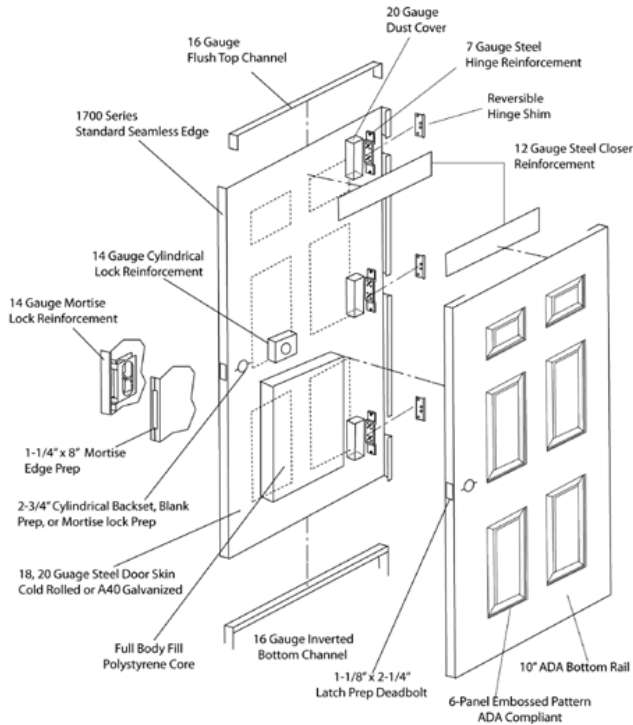

*** Stocked in DFW only**

Nomenclature:

C=161

MB=86 edge blank face

BR=Blank Reinforced For Panic

6 Panel Hollow Metal Doors 18 Gauge

ITEM#	SIZE	HINGE LOCATION	PREP	STEEL	LABEL	WEIGHT LBS.	LIST PRICE
1700	3068	DKS Standard	C	CRS	WHI 3	105	\$606
1701			MB				
1705	C		\$639				
1706	MB						

Hollow Metal Doors 16 Gauge

ITEM#	SIZE	HINGE LOCATION	PREP	STEEL	LABEL	WEIGHT LBS.	LIST PRICE
1622	3068	DKS Standard	C	Galvanized	WHI 3	116	\$894
1604	3070		C			124	\$933
1608			MB			124	\$933
1611	BR		124			\$933	
1601	3068		MB			116	\$894
1620	3080		BR			159	\$1156
1681	3090		MB			180	\$1396
1687	3690		MB			190	\$1886
1693	4090		MB			200	\$2664

Inactive Flush Bolt Prep H.M. Doors 18 Gauge

ITEM#	SIZE	HINGE LOCATION	HAND	PREP	STEEL	LABEL	WEIGHT LBS.	LIST PRICE
2006LIA	3068	DKS Standard	LH	FB/ASA	CRS	WHI 3	105	\$741
2006RIA			RH				105	
2007LIA	3070		Left				107	\$771
2007RIA			Right				107	
2003LIA	2670		LH				87	\$771
2003RIA			RH				87	
2009LIA	3080		LH				118	\$1038
2009RIA			RH				118	

MAKE ALL PURCHASE ORDERS OUT TO DKS

PRICING IS LIST PRICE

Additional sizes and options stocked at DKS' California warehouse.

*** Stocked in DFW only****Continuous Hinge H.M. Doors 18 Gauge, 15/32" undercut in width**

ITEM#	SIZE	HINGE LOCATION	PREP	STEEL	LABEL	WEIGHT LBS.	LIST PRICE
1813CHI	3068	N/A	C	CRS	WHI 3	101	\$631
1818CHI			MB				
1840CHI	3070		C			103	\$658
1847CHI			BR				
G1849CHI	3670						
1863CHI	3080		C			118	\$886
1862CHI			MB				
1864CHI			BR				

1400 Series Steel Stiffened Doors 16 Gauge

HAND	ITEM #	SIZE	PREP	LIST PRICE
RH	1435	3070	C	\$970
LH				
RH	1436	3070	MB	\$970
LH				

1-3/8" Hollow Metal Doors

ITEM#	SIZE	HINGE LOCATION	PREP	STEEL	LABEL	WEIGHT LBS.	LIST PRICE
1112SPL	3068	2 Hinges (See DKS catalog)	C	18 Gauge CRS	-	105	\$618

Retrofit Hollow Metal Doors 18 Gauge

ITEM#	SIZE	HINGE LOCATION	PREP	STEEL	LABEL	WEIGHT LBS.	LIST PRICE
1524	3068	N/A	Lock Side Reinforced	CRS	Not Labeled	99	\$680
1547	3070					106	\$707
1548	4070					134	\$978
1564	3080					118	\$954
1544	2670					90	\$707
1545	2870					95	\$707
1549	3670					124	\$870



MAKE ALL PURCHASE ORDERS OUT TO DKS

PRICING IS LIST PRICE

Additional sizes and options stocked at DKS' California warehouse.



5000 Series Drywall - 16 Gauge * Stocked in DFW only

ITEM#	SIZE	HAND	HINGE LOCATION	ASSEMBLY	DEPTH	LABEL	LIST PRICE
5200	3068	RH	DKS Standard	KD	5.875"	WHI 90	\$298
5201		LH					
5500	3070	RH					\$310
5501		LH					
5609	3080	LH					\$348
5610		RH					
5623	4068	RH					\$304
5624		LH					
5625	4070	RH					\$316
5626		LH					
5635	6068	Pair					\$382
5637	6070	Pair					\$396
5707	3068	RH			\$318		
5708		LH					
5709	3070	RH			\$329		
5710		LH					
5711	3080	RH			\$366		
5712		LH					
5713	4068	RH			\$330		
5714		LH					
5715	4070	RH			\$340		
5716		LH					
5717	4080	RH			\$378		
5718		LH					
5737	3068	RH			\$360		
5738		LH					
5739	3070	RH			\$376		
5740		LH					
5741	3080	RH			\$415		
5742		LH					
5743	4068	RH			\$372		
5744		LH					
5745	4070	RH			\$389		
5746		LH					
5747	4080	RH			\$427		
5748		LH					



MAKE ALL PURCHASE ORDERS OUT TO DKS

PRICING IS LIST PRICE

Additional sizes and options stocked at DKS' California warehouse.



4000 Series Masonry -16 Gauge * Stocked in DFW only

ITEM#	SIZE	HAND	HINGE LOCATION	ASSEMBLY	DEPTH	LABEL	LIST PRICE			
Double Egress Frames			DKS Standard	KD	5.75"	WHI 3				
3000	6068	RH					\$567			
3001		LH								
3010	6080	RH					\$643			
3011		LH								
4002	3070	RH					\$286			
4003		LH								
4500	6070	Pair					\$376			
4082	2668	RH					\$273			
4083		LH								
4084	2670	RH			\$286					
4085		LH								
4100	3068	RH			\$273					
4101		LH								
4104	3070	RH			\$286					
4105		LH								
4108	3068	RH			\$313					
4109		LH								
4112	3070	RH			\$330					
4113		LH								
4124	3668	RH			\$328					
4125		LH								
4122	3670	RH			\$342					
4123		LH								
4128	4070	RH			\$298					
4129		LH								
4116	3080	RH			\$392					
4117		LH								
4118	4080	RH			\$403					
4119		LH								
4511	6070	Pair			\$431					
4525	8070	Pair			\$445					
4733	3070	RH			\$326					
4734	3070	LH								
4745	4070	RH			\$344					
4746	4070	LH								
4220	3068	RH			\$364					
4221		LH								
					7.125"					
					7.75"					



MAKE ALL PURCHASE ORDERS OUT TO DKS

PRICING IS LIST PRICE

Additional sizes and options stocked at DKS' California warehouse.



4000 Series Masonry -16 Gauge * Stocked in DFW only

ITEM#	SIZE	HAND	HINGE LOCATION	ASSEMBLY	DEPTH	LABEL	LIST PRICE
4224	3070	RH	DKS Standard	KD	7.75"	WHI3	\$364
4225		LH					\$364
4228	3080	RH					\$374
4229		LH					\$374
4451	4068	RH					\$385
4452		LH					\$385
4453	4070	RH					\$396
4454		LH					\$396
4230	4080	RH					\$447
4231		LH					\$447
4534	6068	Pair					\$485
4542	6070	Pair					\$505
4450	6080	Pair			\$556		
4340	3068	RH			\$389		
4341		LH			\$389		
4344	3070	RH			\$403		
4345		LH			\$403		
4348	3080	RH			\$445		
4349		LH			\$445		
4455	4068	RH			\$416		
4456		LH			\$416		
4457	4070	RH			\$431		
4458		LH			\$431		
4350	4080	RH			\$472		
4351		LH			\$472		
4569	6068	Pair			\$550		
4570	6070	Pair			\$568		
4463	6080	Pair			\$600		
4800	3068	RH			\$337		
4801		LH			\$337		
4803	3070	RH	\$358				
4804		LH	\$358				
4459	3080	RH	\$444				
4460		LH	\$444				
4806	4068	RH	\$361				
4807		LH	\$361				
4809	4070	RH	\$374				
4810		LH	\$374				
4461	4080	RH	\$472				
4462		LH	\$472				
4539	6068	Pair	\$478				
4540	6070	Pair	\$495				
4541	6080	Pair	\$521				



MAKE ALL PURCHASE ORDERS OUT TO DKS

PRICING IS LIST PRICE

Additional sizes and options stocked at DKS' California warehouse.



4" FACE HEADS 16 Gauge

Blank Masonry Stick Material

ITEM#	DEPTH	SIZE	STEEL	LISTPRICE
57530H4	36"	5.75"	CRS	\$120
57540H4	48"	5.75"	CRS	\$131
57560H4	72"	5.75"	CRS	\$152

ITEM#	DEPTH	SIZE	TYPE	LISTPRICE
7000	5.75"	10'	Galvanized	\$147
CO7000	5.75"	10"	Cased Open	\$165
MUL575	5.75"	10"	Blank Mullion	\$285

Door and Frame Handing Chart

SINGLE SWING DOORS

When door swings towards you and hinges are on right side of the door – **Door is R.H.R. / Frame is L.H.**
 When door swings inside and hinges are on right side of the door – **Door is R.H. / Frame is R.H.**

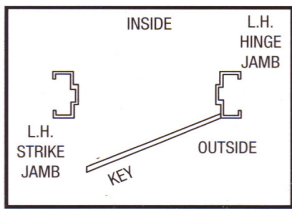

Right Hand Reverse Door (Swing Out) Left Hand Frame

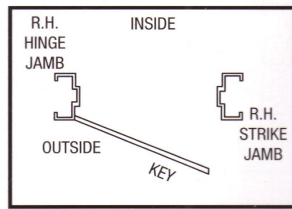

Left Hand Reverse Door (Swing Out) Right Hand Frame

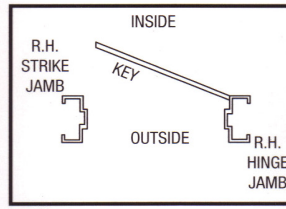

Right Hand Door (Swing In) Right Hand Frame

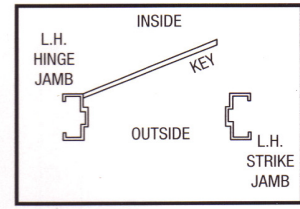

Left Hand Door (Swing In) Left Hand Frame

DOUBLE DOORS

When door leaf swing towards you and hinges are on the right side of active leaf – **Door is R.H.R Active / Frame is L.H. Active**

When door leaf swing inside and hinges are on the right side of active leaf – **Door is R.H. Active / Frames is R.H. Active**

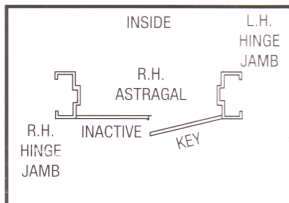

OUTSIDE
 Pair of Doors – R.H.R. Active (Swing Out)
 Double Door Frame L.H. Active

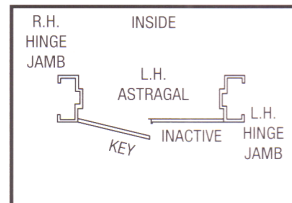

OUTSIDE
 Pair of Doors – L.H.R. Active (Swing Out)
 Double Door Frame R.H. Active

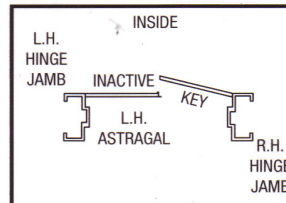

OUTSIDE
 Pair of Doors – R.H. Active (Swing In)
 Double Door Frame R.H. Active

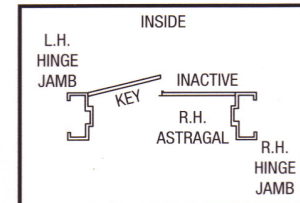

OUTSIDE
 Pair of Doors – L.H. Active (Swing In)
 Double Door Frame L.H. Active

MAKE ALL PURCHASE ORDERS OUT TO DKS

PRICING IS LIST PRICE

Additional sizes and options stocked at DKS' California warehouse.

(Minimum Order \$50 or \$8 Service Charge Added)



EXP 4000 Expandable Masonry Frames

*** Stocked in DFW & Houston**

**16 Gauge Galvanized
5.625" to 8.75" Depth
Expandable Masonry Frame
90 Minutes WHI**

The DKS "EXP" adjustable frame is a three piece system designed to adjust to multiple depth wall conditions. Slide rails placed inside the frame throat allow the frame to accommodate all jamb depths from 4 5/8" to 7 3/4" using a single frame.

The frame material used in manufacturing is A-40 galvanized 16 gauge. Prime Painted with two part epoxy baked on at the factory.

Three 7 gauge 4.5 x 4.5 hinge reinforcements for 6'8" and 7'0" heights. Four 7 gauge hinge reinforcements for 8'0" height frames. All locations are DKS Standard. All hinge reinforcements are prepared to accept standard weight or heavy weight template hinges. The ASA strike reinforcement is 12 gauge material drilled and tapped to accept 12-24 screws.

The frame is prepared for silencer application.

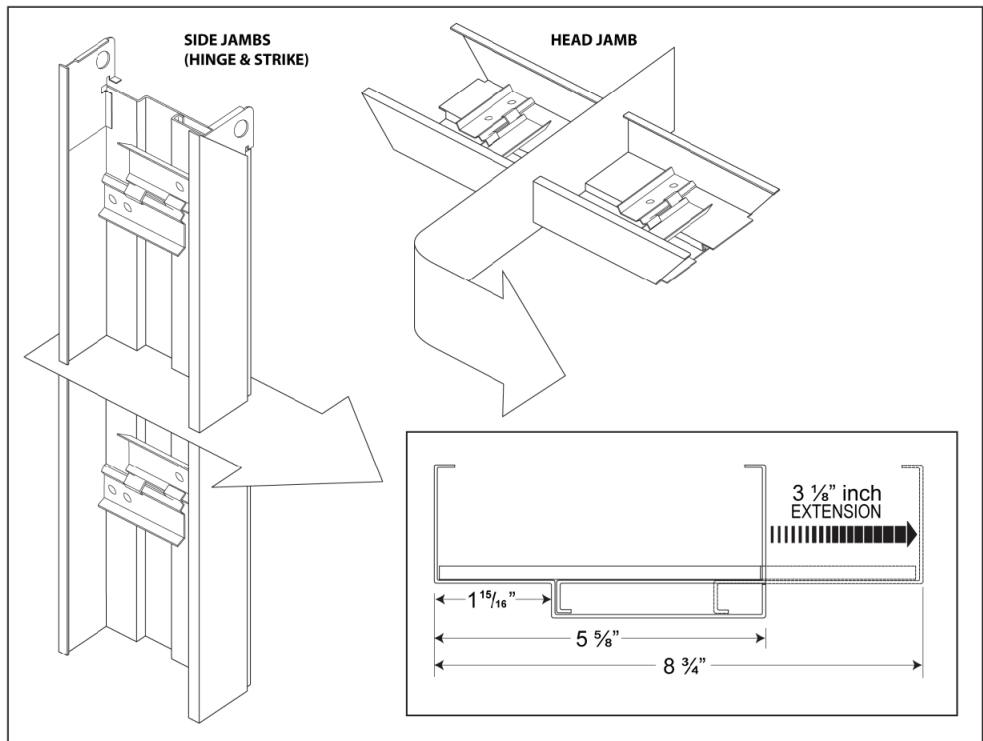

COMPLETE FRAME SIZES			
	WIDTH	HEIGHT	LIST PRICE
S I N G L E	3'0"	6'8"	\$518
		7'0"	\$534
		8'0"	\$562
	3'6"	6'8"	\$531
		7'0"	\$548
		8'0"	\$576
4'0"	6'8"	\$542	
	7'0"	\$559	
	8'0"	\$587	
P A I R	6'0"	6'8"	\$594
		7'0"	\$611
		8'0"	\$639

FRAME COMPONENTS		
PART	LENGTH	LIST PRICE
HINGE JAMB	6'8"	\$223
	7'0"	\$231
	8'0"	\$245
STRIKE JAMB	6'8"	\$212
	7'0"	\$220
	8'0"	\$233
SINGLE HEAD	3'0"	\$84
	3'6"	\$99
	4'0"	\$110
PAIR HEAD	6'0"	\$149

HOW TO ORDER		
Example: 3070 Part # 5625 (5.625" to 8.75") Expandable Masonry Right Hand Frame		
TYPE	SIZE	PART
X	305625	H
X	705625	HJR
X	705625	SJR
TYPE	X (Expandable Masonry)	
SIZE	Width / Height	
PART	H (Head), HJ (Hinge Jamb Right or Left), SJ (Strike Jamb Right or Left), PR (Pair Head)	



MAKE ALL PURCHASE ORDERS OUT TO DKS

PRICING IS LIST PRICE

Additional sizes and options stocked at DKS' California warehouse.

(Minimum Order \$50 or \$8 Service Charge Added)



EXP 5000 Expandable Drywall Frames

*** Stocked in DFW & Houston**

**16 Gauge Galvanized
5.625" to 8.75" Depth
Expandable Drywall Frame
90 Minutes WHI**

The DKS "EXP" adjustable frame is a three piece system designed to adjust to multiple depth wall conditions. Slide rails placed inside the frame throat allow the frame to accommodate all jamb depths from 4 5/8" to 7 3/4" using a single frame.

The frame material used in manufacturing is A-40 galvanized 16 gauge. Prime Painted with two part epoxy baked on at the factory.

Three 7 gauge 4.5 x 4.5 hinge reinforcements for 6'8" and 7'0" heights. Four 7 gauge hinge reinforcements for 8'0" height frames. All locations are DKS Standard. All hinge reinforcements are prepared to accept standard weight or heavy weight template hinges. The ASA strike reinforcement is 12 gauge material drilled and tapped to accept 12-24 screws.

The frame is prepared for silencer application.

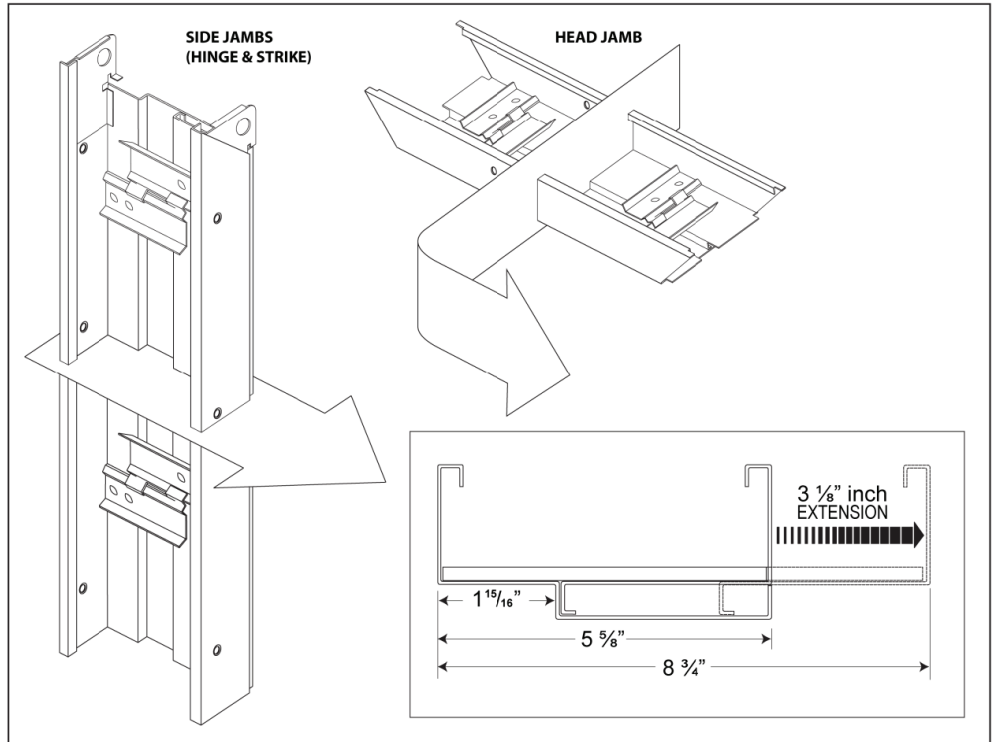

COMPLETE FRAME SIZES			
	WIDTH	HEIGHT	LIST PRICE
S I N G L E	3'0"	6'8"	\$518
		7'0"	\$534
		8'0"	\$562
	3'6"	6'8"	\$531
		7'0"	\$548
		8'0"	\$576
4'0"	6'8"	\$542	
	7'0"	\$559	
	8'0"	\$587	
P A I R	6'0"	6'8"	\$594
		7'0"	\$611
		8'0"	\$639

FRAME COMPONENTS		
PART	LENGTH	LIST PRICE
HINGE JAMB	6'8"	\$223
	7'0"	\$231
	8'0"	\$245
STRIKE JAMB	6'8"	\$212
	7'0"	\$220
	8'0"	\$233
SINGLE HEAD	3'0"	\$84
	3'6"	\$99
	4'0"	\$110
PAIR HEAD	6'0"	\$149

HOW TO ORDER		
Example: 3070 Part # 5625 (5.625" to 8.75") Expandable Masonry Right Hand Frame		
TYPE	SIZE	PART
X	305625	H
X	705625	HJR
X	705625	SJR
TYPE	X (Expandable Masonry)	
SIZE	Width / Height	
PART	H (Head), HJ (Hinge Jamb Right or Left), SJ (Strike Jamb Right or Left), PR (Pair Head)	

MAKE ALL PURCHASE ORDERS OUT TO DKS

ACCESSORIES PRICING IS NET PRICE

Additional sizes and options stocked at DKS' California warehouse.

(Minimum Order \$50 or \$8 Service Charge Added)



ACCESSORIES

ILLUSTRATION	ITEM#	DESCRIPTION	LIST PRICE
	ZAST68	6'8" Z Astragal Flush Bolt & ASA Prep Non-Handed	\$44.35
	ZAST70L ZAST70R	7'0" Z Astragal LEFT 7'0" Z Astragal RIGHT	\$45.52
	ZAST80L ZAST80R	8'0" Z Astragal LEFT 8'0" Z Astragal RIGHT	\$71.50
	ZAST-ASA68NH	6'8" Z Astragal ASA Prep Only Non-Handed	\$44.35
	ZAST-ASA70LH	7'0" Z Astragal LEFT HAND ASA Prep Only	45.52
	ZAST-ASA70RH	7'0" Z Astragal RIGHT HAND ASA Prep Only	
	AST68	6'8" Z Astragal No Hardware Prep	54.58
	AST70	7'0" Z Astragal No Hardware Prep	59.00
	AST80	8'0" Z Astragal No Hardware Prep	68.07

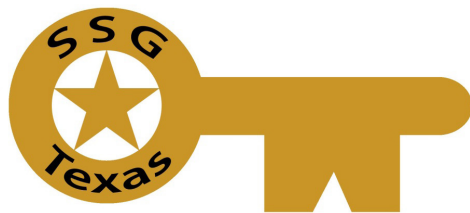

2020 Exchange Drive Arlington, Texas 75050 • Phone 817-275-3070
Website: <http://www.ssg-texas.com>